

MOVEX®

ME 75



The ideal extractor for laboratory environments.

With its optimal design, the Ø 3 inch Movex ME has a very low pressure drop, which provides many valuable benefits:

- Low pressure drop saves energy.
- Air flow noise is reduced.
- Lower pressure drop is achieved without selecting a larger diameter extractor.
- Lower pressure drop allows the ME to be combined with additional extraction systems.

Unique design and stable mounting brackets make the Movex ME your best choice.

Support for designing an efficient facility is available on page 5, and at www.movexinc.com where you will find our design tool and CAD drawings.

The Movex range also includes fans, accessories, automatic controls and filters suitable for local extraction.

MOVEX ME 75

Always choose a low pressure drop

Lowest possible pressure drop is a quality aspect that always should be considered.

With its uniquely designed joint construction, the Movex ME combines maximum flexibility with low pressure drop. The air passes through the joints without creating unnecessary turbulence, thus producing an energy-saving low pressure drop and a quieter working environment.



Recommended air flow

The recommended air flow for a \varnothing 3" arm is 70-85 cfm. See table and diagram.

Activity	Air flow
Laboratories	70-85 cfm
Schools – science classrooms	70-85 cfm

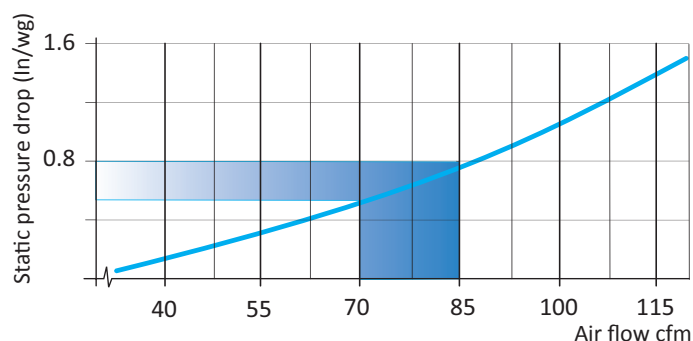

Static pressure drop is measured in accordance with ISO standard 5167-1.

Optimal capture

For optimum benefit from the local extractor, it is important to use the flexibility of the extractor to get as close to the contaminant as possible. A good rule of thumb would be a distance of 2–3 times the diameter of the extractor tube. At the recommended air flow, the extractor will provide high efficiency even if disturbances are generated in the surroundings.

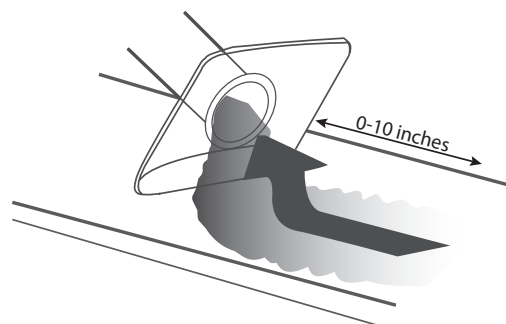

Unique benefits

The Movex ME joints have a patented friction design that, combined with the large joint diameter and single grip handle, provide a secure, position-stable arm with smooth adjustments. All without the need to apply excessive force or use tools on the adjusting knob.

Joints with reinforced ends and ball bearings moderate the friction and allow the arm to be moved up and down while maintaining stability and function.

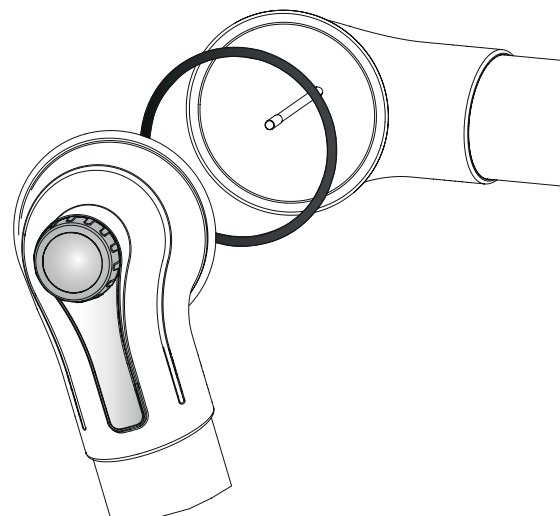

MOVEX® ME 75

One arm. All options.

The Movex ME has a complete range of accessories to suit every situation, enabling you to create the optimal extractor for the evacuation of hazardous airborne gases and particulates.



Standard version

Suitable for evacuating most types of airborne contaminants, e.g. in laboratories, schools, hospitals, the pharmaceutical industry, nail salons and light industrial applications.



PP version

Used primarily for evacuating very corrosive contaminants in high concentrations, e.g. in certain laboratories and in the pharmaceutical and chemical industries.



ESD version



Suitable for evacuating airborne contaminants in environments where there is a need to avoid the risk of spark formation and in areas where products need to be ESD-certified, e.g. the electronics industry.



ATEX version



Suitable for evacuating airborne contaminants where there is a requirement for an ATEX-classified environment, e.g. in laboratories, the chemical and petrochemical industries, gas distribution, and the paint and pharmaceutical industries.



The MET with internal mechanical spring for ceiling and wall mounting

Standard	Size (inch)				Weight (lb)
	A	B	Total length	Ø C	
MET 1000-75	16	12	40	3"	4.95
MET 1300-75	22	18	51	3"	5.70
MET 1500-75	30	18	60	3"	6.05
MET 2000-75	40	26	80	3"	7.15

PP	Size (inch)				Weight (lb)
	A	B	Total length	Ø C	
MET 1000-75PP	16	12	40	3"	4.95
MET 1300-75PP	22	18	51	3"	5.70
MET 1500-75PP	30	18	60	3"	6.05

ATEX	Size (inch)				Weight (lb)
	A	B	Total length	Ø C	
MET 1000-75EX	16	12	40	3"	4.95
MET 1300-75EX	22	18	51	3"	5.70
MET 1500-75EX	30	18	60	3"	6.05

ESD	Size (inch)				Weight (lb)
	A	B	Total length	Ø C	
MET 1000-75ES	16	12	40	3"	4.95
MET 1300-75ES	22	18	51	3"	5.70
MET 1500-75ES	30	18	60	3"	6.05

MET

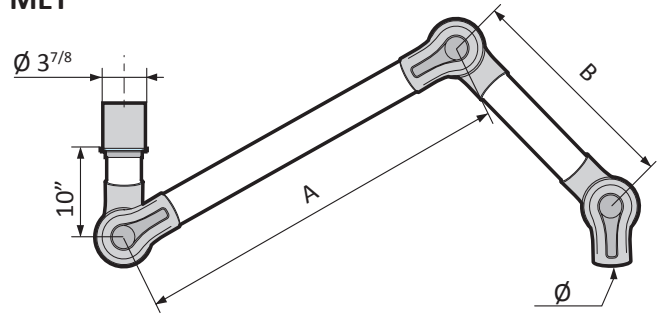

Add MTI bracket for ceiling mounting.
Add MVK bracket for wall mounting.

The METS with external gas spring

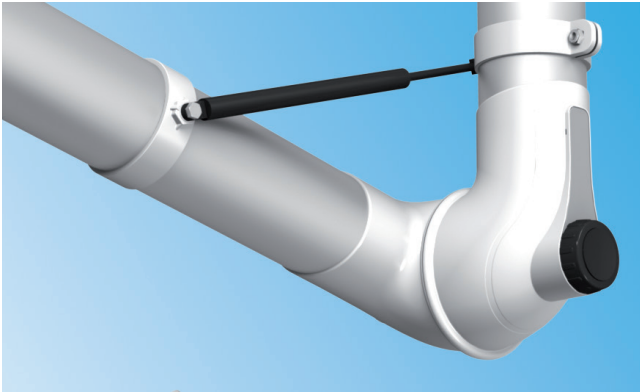

For arms of length 60 inches and 80 inches, Movex recommends the gas spring model to provide better stability.

The gas spring can also be used as a height stop, e.g. on low ceilings and where there are low electrical fittings.

Standard	Size (inch)				Weight (lb)
	A	B	Total length	Ø C	
METS 1500-75	30	18	60	3"	6.05
METS 2000-75	40	26	80	3"	7.15

PP	Size (inch)				Weight (lb)
	A	B	Total length	Ø C	
METS 1500-75PP	30	18	60	3"	6.05
METS 2000-75PP	40	26	80	3"	7.15

ATEX	Size (inch)				Weight (lb)
	A	B	Total length	Ø C	
METS 1500-75EX	30	18	60	3"	6.05
METS 2000-75EX	40	26	80	3"	7.15

ESD	Size (inch)				Weight (lb)
	A	B	Total length	Ø C	
METS 1500-75ES	30	18	60	3"	6.05
METS 2000-75ES	40	26	80	3"	7.15

METS

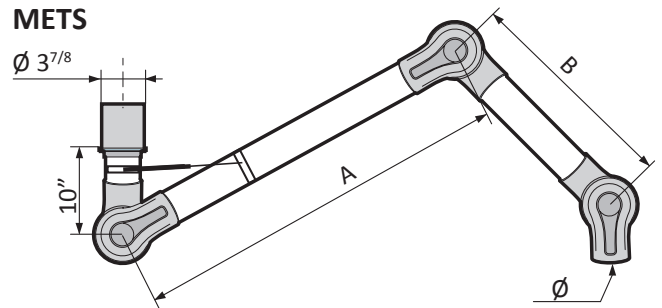

Add MTI bracket for ceiling mounting.
Add MVK bracket for wall mounting.

MOVEX ME 75

The MEB with internal mechanical spring for table mounting

Standard	Size (inch)				Weight (lb)
	A	B	Total length	Ø C	
MEB 1000-75	16	12	40	3"	4.95
MEB 1300-75	22	18	51	3"	5.70
MEB 1500-75	30	18	60	3"	6.05

PP	Size (inch)				Weight (lb)
	A	B	Total length	Ø C	
MEB 1000-75PP	16	12	40	3"	4.95
MEB 1300-75PP	22	18	51	3"	5.70
MEB 1500-75PP	30	18	60	3"	6.05

ATEX	Size (inch)				Weight (lb)
	A	B	Total length	Ø C	
MEB 1000-75EX	16	12	40	3"	4.95
MEB 1300-75EX	22	18	51	3"	5.70
MEB 1500-75EX	30	18	60	3"	6.05

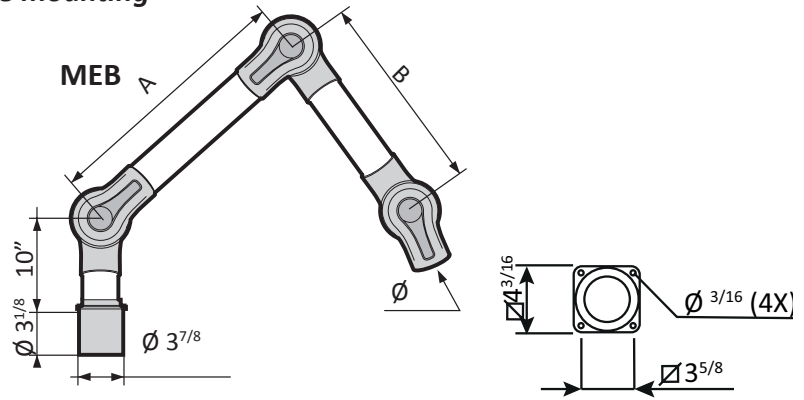

ESD	Size (inch)				Weight (lb)
	A	B	Total length	Ø C	
MEB 1000-75ESD	16	12	40	3"	4.95
MEB 1300-75ESD	22	18	51	3"	5.70
MEB 1500-75ESD	30	18	60	3"	6.05

Reach at recommended installation height

The following installation heights and side displacement relative to the work area are recommended for optimal extraction:

Recommended installation height

Designation	H (inches)
MET 1000-75	64-76
MET 1300-75	72-84
MET/S 1500-75	76-88
MET/S 2000-75	84-96

Recommended side displacement

radius, relative to work area

Designation	S (inches)
MET 1000-75	12-24
MET 1300-75	16-24
MET/S 1500-75	20-32
MET/S 2000-75	28-40

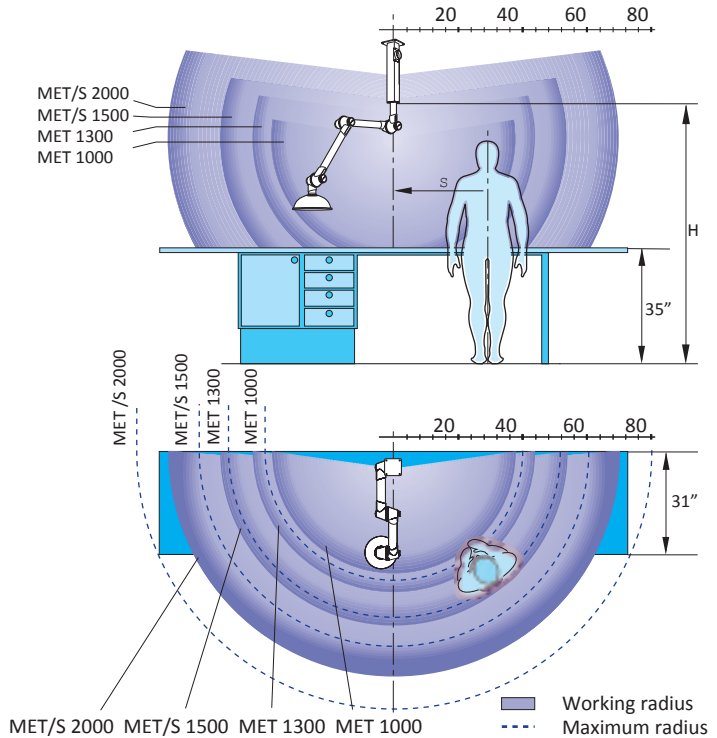

Pressure drop

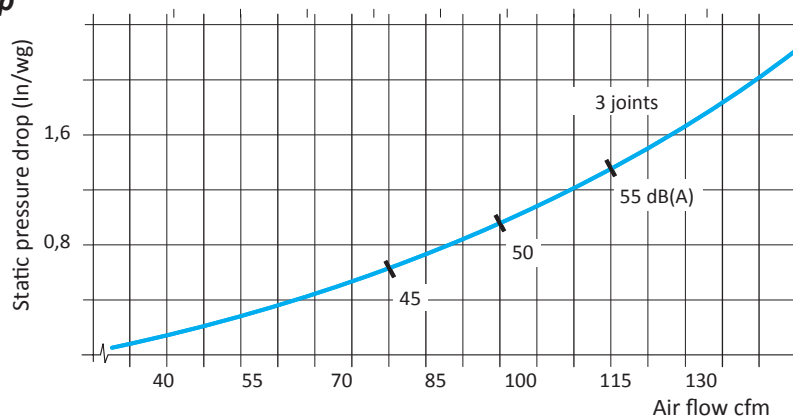

Static pressure drop is measured in accordance with ISO standard 5167-1.
Noise level is measured in accordance with ISO standard 3743.
Indicated sound level refers to sound pressure level.

Hoods

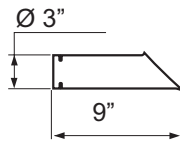

SUCTION NOZZLE

The suction nozzle is used in tight spaces and for getting close to the work without interfering.

Temp. range: -5°F to +176°F

Standard	Variants	Weight (oz)
MES 300-75	PP,ES,EX	5.6

Material
Standard: Aluminum
PP Polypropylene
ES, EX PEEL black

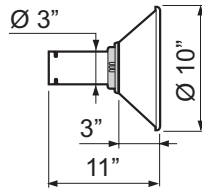

METAL HOOD

The metal hood is used when working in corrosive environments and for capturing hot gasses and dust splatter.

Metal hoods can be fitted with work lighting.

Temp. range: -5°F to +176°F

Standard	Variants	Weight (oz)
MEM 250-75	PP,ES,EX	11.8

Material
Standard/PP: Powder-coated aluminum
ES Aluminum
EX Powder-coated aluminum

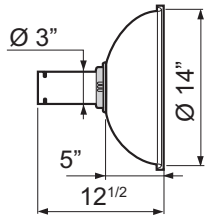

DOME HOOD

The clear dome hood is suitable for lighter gasses with a wider dispersal of contaminants without blocking the user's vision.

Temp. range: -5°F to +176°F

Standard	Variants	Weight (oz)
MEK 350-75	PP,ES,EX	15.9

Material
Standard: PMMA, clear
PP Polypropylene, translucent
ES, EX PEEL black

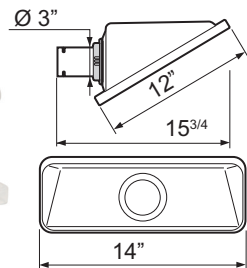

SQUARE HOOD

The square hood is suitable for placing above gasses with a high lift, or adjacent to the work surface for contaminants with no lift or low lift – all this without interfering with the work.

Temp. range: -5°F to +176°F

Standard	Variants	Weight (oz)
MESH 350-75		17.1

Material
Standard: PETG,clear

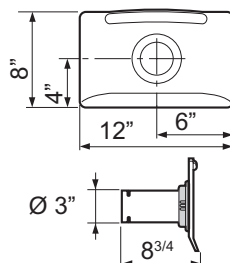

FLAT SCREEN HOOD

The flat screen hood is designed to maximise the working area without obscuring the object from the user. The flat screen hood gives the best suction effect for table and bench tasks.

Temp. range: -5°F to +176°F

Standard	Variants	Weight (oz)
MEPH 300-75	PP,ES,EX	12.9

Material
Standard: PETG,clear
PP Polypropylene
ES, EX PEEL black

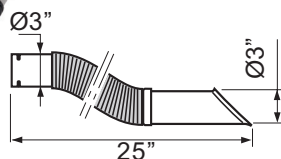

FLEXIBLE SUCTION NOZZLE

The flexible suction nozzle is designed to maximise ease of movement without sacrificing air flow efficiency. Available in the ESD version only.

Temp. range: -5°F to +176°F

Standard	Variants	Weight (oz)
MFS 600-75ES	-	15.0



PROTECTIVE GRILL

Protective grill to be monted in joints. Prevents objects being sucked into the system.

Temp. range: -5°F to +176°F

Standard	Variants	Weight (oz)
MSG-75	ES,EX	0.4

Brackets



All Movex laboratory extractors have as standard a full swivel that allows 360° of rotation without the need to add special sleeve couplings.

Both ceiling and wall brackets have a special square-shaped profile in anodized aluminum to provide a stylish and stable installation. This aluminum profile also allows both the wall and ceiling brackets to be custom tailored at the job site.

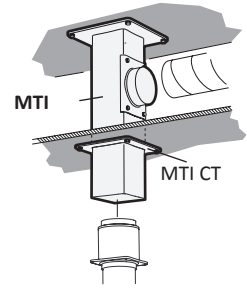

The MTI and MTF ceiling bracket

The ceiling bracket functions as a simple and stable duct for outgoing air, avoiding the need for expensive ducting and additional holes through false ceilings. **On request, the MTI can be supplied in lengths exceeding 80 inches.**

Standard	Dimensions (inches)	Weight (lb)
	L	
MTI 250	10	6.9
MTI 500	20	8.4
MTI 750	30	9.9
MTI 1000	40	11.4
MTI 1250	50	12.9
MTI 1500	60	14.4
MTI 1750	70	15.9
MTI 2000	80	17.4

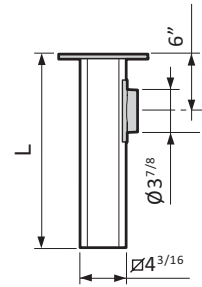
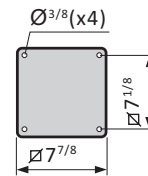
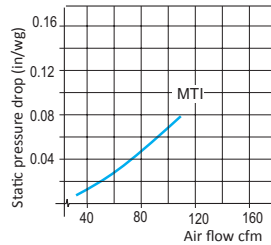

Ceiling bracket, for fitting through beams. The attachment plate is adjustable for the entire length of the aluminum profile. If required, the aluminum profile can be cut during fitting.

Standard	Dimensions (inches)	Weight (lb)
	L	
MTF	40	9.3

As well as the standard design, the MTI/MTF is available in an ESD (ES) or ATEX (EX) version. The ceiling brackets can be supplied with an epoxy-coated exterior in all lengths. For aggressive environments, we recommend epoxy coating on the interior and exterior.

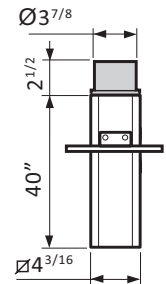
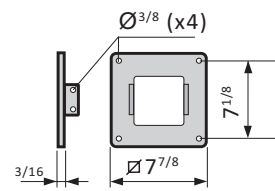

The MTI CT escutcheon plate

Escutcheon plate, used with the MTI ceiling bracket for stabilization and to cover the rough cut in false ceilings.

Standard	Weight (oz)
	MTI CT

As well as the standard design, the escutcheon plate is available in an ESD (ES) or ATEX (EX) version.

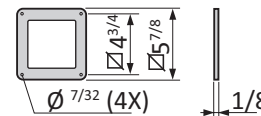

MVK wall bracket

Wall brackets can be special ordered in custom horizontal and vertical lengths.

Standard	Weight (lb)
	MVK

As well as the standard design, the wall bracket is available in an ESD (ES) or ATEX (EX) version.

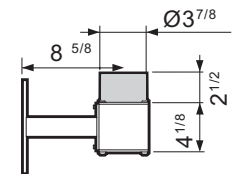
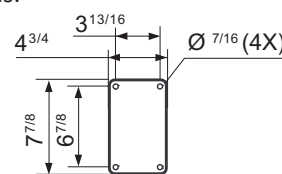

MBF flexible table bracket

Flexible bracket for attaching to a table-top or shelving. Supplied complete with two clamps.

Standard	Weight (lb)
	MBF

As well as the standard design, the table bracket is available in an ESD (ES) version.

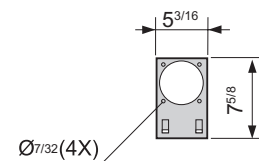
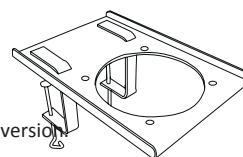

MRM reducing sleeve

Polypropylene, fits standard Ø 3 7/8" attachment, for reducing down to Ø 3".

Standard	Weight (oz)
	MRM 100-75

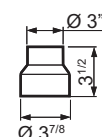



Material description

Friction joints

Ball bearing-equipped adjustable friction joints in polypropylene (PP), with guide ring in low friction-treated rubber. Support springs and other component parts in zinc-plated steel or stainless steel.

Tubes

Made from thin-walled anodized aluminum; alternate from polypropylene. Air-tight damper supplied as standard.

ME Standard

The standard ME version has polypropylene joints and anodized aluminum tubes.

The standard ME version is suitable for evacuating most types of airborne contaminants, e.g. in laboratories, schools, hospitals, the pharmaceutical industry, nail salons and light industrial applications.

ME PP

Polypropylene joints and tube version. All metallic parts that are in contact with the air flow are made of stainless steel. The PP version of the ME is used primarily for evacuating very corrosive contaminants in high concentrations, e.g. in certain laboratories and in the pharmaceutical and chemical industries. When using a PP extractor fitted to a ceiling, we recommend that you order the MTI ceiling bracket with an internal epoxy coating.

ME ATEX



Conductive polypropylene joints and tubes. All metallic parts that are in contact with the air flow are made of stainless steel. Static electricity is diverted to a separate earth connection. All steel supporting parts are lined in a conductive powder coating. The product meets the requirements of category 2 of the ATEX directive (94/9/EC) for gases and dust.

The ATEX version of the ME is suitable for evacuating airborne contaminants where there is a requirement for ATEX-classified products, e.g. laboratories, the chemical and petrochemical industries, gas distribution, and the paint and pharmaceutical industries.

ME ESD



Joints and tubes are made from conductive propylene, making the entire arm electrically conductive and diverting any static electricity to a separate earth connection.

The ESD version of the ME is suitable for the evacuation of airborne contaminants in environments where there is a need to avoid the risk of spark formation caused by static electricity and in areas where products need to be ESD-certified for use, e.g. the electronics industry. The ME ESD has been approved in accordance with EN 61340-5-1.

Delivery

Ceiling/ Wall MET Supplied assembled, excluding hood. The ceiling or wall brackets should be ordered separately.

Table-MEB Supplied assembled, with attachment plate for table fitting, excluding hood. The MBF flexible table bracket should be ordered separately.

MOVEX®

104 Commerce Drive, Northampton, PA 18067, USA

Phone: 610 440-0478, Fax: 610 440-0480

www.movexinc.com info@movexinc.com