



perfectly organised

more space system



Company headquarter

Novus Dahle GmbH & Co. KG
Breslauer Strasse 34-38
49808 Lingen
Germany

Tel. +49 (0) 591/9140-0
Fax +49 (0) 591/9140-841

Web: www.novus.de
E-mail: info@novus-dahle.com

Content

Competences		04 - 15
References		16 - 33
Novus products		34 - 129
More space sets		34 - 43
Flat-screen holders	NOVUS MY NOVUS Tetra Support System NOVUS LiftTEC® NOVUS ScreenMount Accessories	44 - 103
Lighting		104 - 113
Office organisation	Universal support arms Trays and shelves Display pocket holders Additional mounts	114 - 129
Symbol explanation		130 - 131
emco Group		132 - 133

Clever solutions, combined in any way you like for **more space** and flexibility.



Efficiency and convenience at any workstation: since the company was founded in 1949, the Novus brand has been synonymous with innovative and technically advanced office products developed in the spirit of “German Engineering”. Novus is part of the emco Group, four strong brands united in one group. The expertise and products segments covered within the group generate effects of synergy that not only benefit the brands involved – but above all emco Group’s customers and partners.

As a holding positioned on the international stage, the emco Group is consciously and resolutely committed to high standards in quality, safety and environmental protection. This also includes a clearly defined ecology concept based on the EN ISO 14001 environment management system in place world-wide. At the company’s own production facilities, state-of-the-art equipment and efficient processes ensure optimum production conditions.

Products developed in-house at Novus are synonymous with solutions of exceptionally high quality, functionality and long life. Quality management holding certification under DIN EN ISO 9001 confirms that practice at Novus meets the level of international quality standards.



MORE SPACE

by using space efficiently.





The flexibility to organise any workplace with perfection.

The systematic layout of different elements, such as monitor, light and telephone, as well as adding useful accessories brings order and neat organisation to the office. Using the third level provides space for working even more productively – wherever needed.

ERGONOMICS

for a healthy posture.





Responding with flexibility to individual needs.

For Novus, the focus is on the human element – and for good reason. This is the only way of creating workspaces that are perfectly tailored to the needs of every individual.



FLEXIBILITY

by options combined in any chosen way.





Leaving room for changes.

The system-based philosophy behind the Novus more space system provides space for all sorts of organisational options. Because with the various products being so easy to combine, the system can be extended to meet any need even after years down the line.



QUALITY

reflected in every detail.

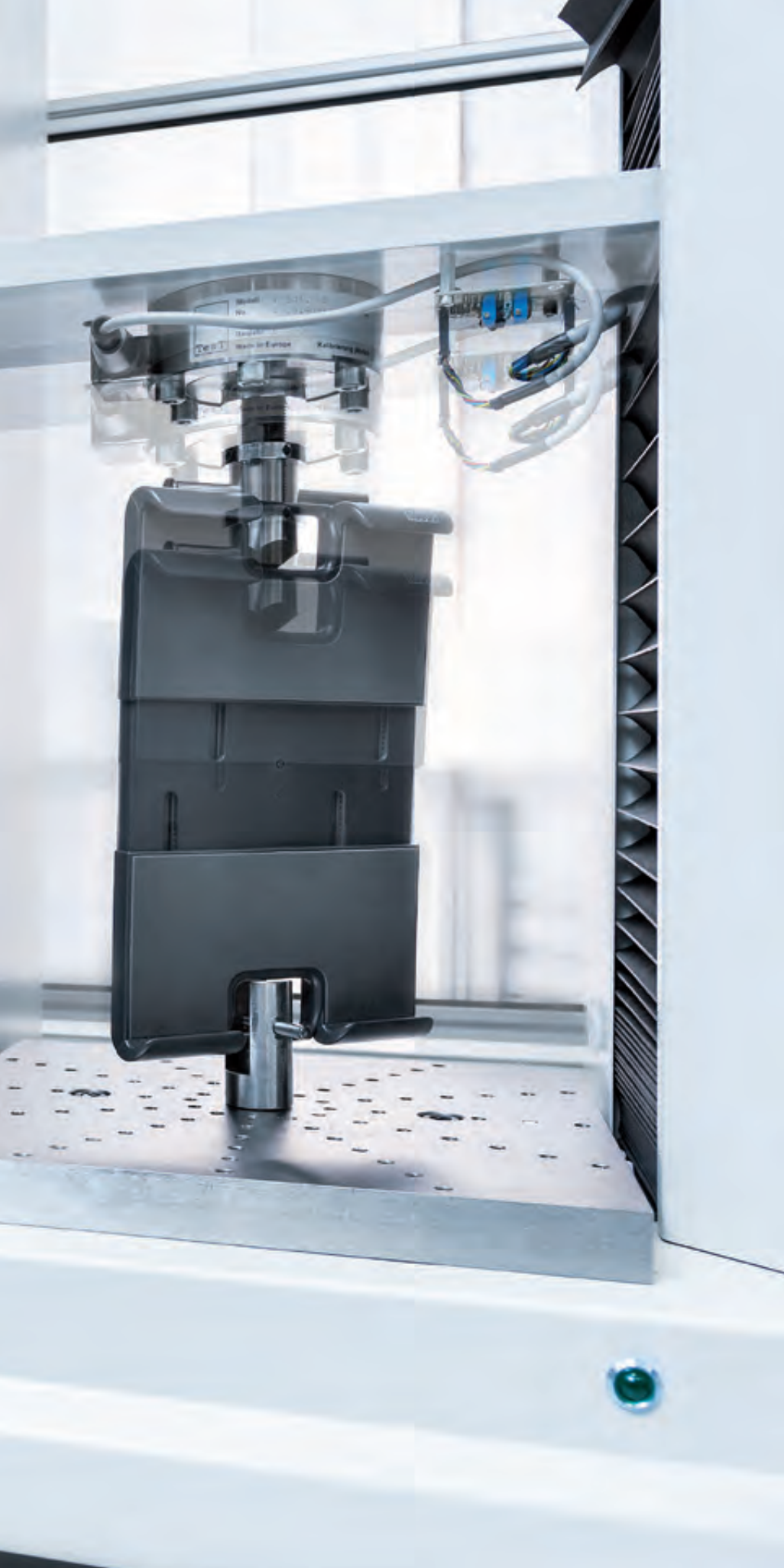

Always a good feeling.

The guaranteed high standard of quality in our products, which has been verified in tests, is not only expressed in terms of durability. The high-quality materials also prove their strength in meeting the demands of everyday work – appreciated by users everyday.



Focus on user success.

Novus has a commitment to German Engineering across the board. This quality hallmark only goes to products that are developed by our engineers and manufactured worldwide at our own production facilities. This allows us to meet customer needs and the latest market demands with speed and flexibility.



INDIVIDUAL SOLUTIONS

for a variety of requirements.



Convincing references at every workstation.

“Great design is intuitively recognised, in its meaning, function and emotion.”

Design is a main part of a product. Especially in a workspace environment product design encourages the individual productivity. Novus products stand for clear, high quality design.

Georg Kaluza, Designer





From desk to efficient work space.

Solutions for office workspace.

Nowadays, a modern workstation is used in many different ways. This means the various components involved, like monitor arm, telephone support etc., must also provide the required level of flexibility.

The Novus more space system impressively demonstrates how existing workspace can be efficiently organised and tailored to suit individual needs.



Call centre



Dual-screen solution

Everything in view

thanks to perfect organisation.

Solutions for control rooms.

Specific tasks demand professional workstations: this is why working in front of several monitors at one and the same time is all part of standard practice in control rooms and control centres. All the more important to make intelligent use of existing space.

The Novus more space system provides the capability of combining several monitors so as to present the full picture.

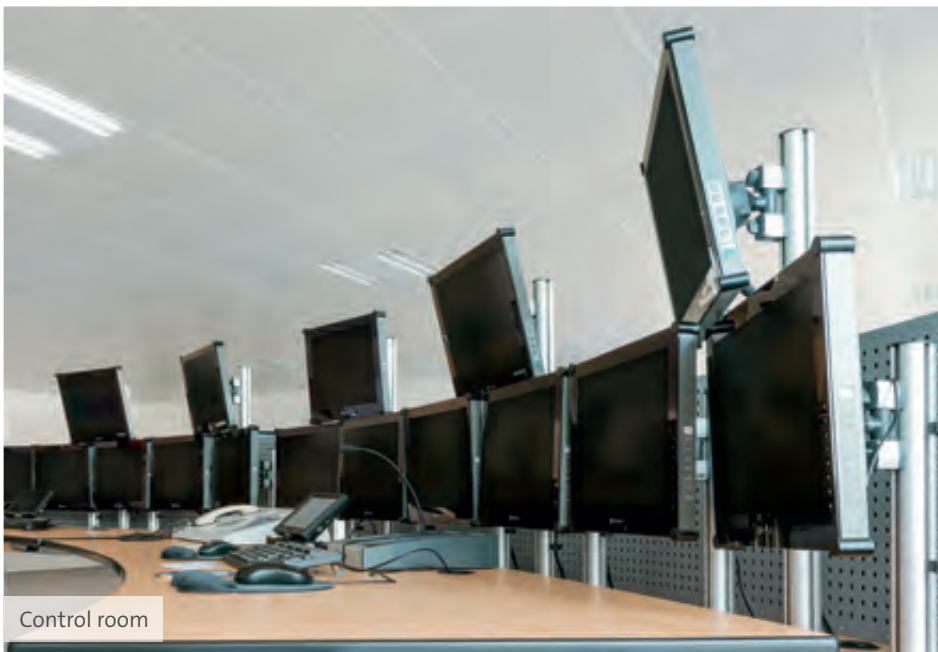

Control room





Police headquarters



Insurance company

Perfectly organised – whether alone or in dialogue.



Solutions for consultancy.

At workstations involving contact with customers, tidiness and a well-structured layout help to create a pleasant and productive atmosphere.

Having all supporting information clearly in view makes conversation more confident in a targeted manner.



Bank

Better use of space all round.



Solutions for communicative areas.

Cost-efficient space organisation and communicative workplaces are not mutually exclusive. Designed and planned properly as well as tailored to existing space, there's an ideal solution to suit any situation – with one system that is equally suited to all members of staff and yet provides maximum flexibility in terms of configuration.



Bench solution





Television studio

Perfect posture at all times.

Solutions for media production.

A live show or broadcast is a particular challenge to any television producer. When stress affects the posture, problems may occur.

The Novus more space system ensures ergonomic posture – at 5 in the morning just as it does at midnight.



Editorial department

A stable support for systematic production.

Solutions for production/industry.

Even under high workload, responsible staff has to stay on top of things all the time.

The Novus more space system provides clear structures for efficient workflows – helping to ensure cost-effective and efficient processes long-term.





Assembly workstation

Warmly welcomed and well informed.

Solutions for reception areas.

A friendly reception creates trust and a warm welcome. The Novus More Space System contributes to this with solutions that meet the highest visual requirements in various areas.

Our products enable tablet PC's to be safely used as information points or digital signage – a solution that is flexible, attractive and welcoming.



Reception



Show room

Sophisticated **product range**
for **customised solutions.**





Cleverly **combined**
solutions to meet all needs.

Sophisticated combinations for
diverse workstation designs.





Customised complete furnishings
for more free space without any compromises.



NOVUS TSS Basic

- Novus bestseller for ergonomically correct use of the flat screen at your workstation
- Height of the column: 445 mm
- Mounting standard 75/100 mm
- Table mounting with system clamp 1 for a table thickness of 14-40 mm
- Carrying capacity: monitor weight 12 kg, infinitely variable height
- Range: folding arm III 505 mm

Comprising:

- TSS column 445 system clamp 1
- TSS folding arm III



Colours	Art.No.	EAN Code
	220+0050+000	4009729046616



NOVUS TSS Basic & Light

- The space-saving combination of flat screen support and lighting
- Height of the column: 445 mm
- Mounting standard 75/100 mm
- Column attachment: system clamp 1, clamping length 14-40 mm
- Carrying capacity: monitor weight 10 kg, infinitely variable height
- Range: TSS-Faltarm II 450 mm / OfficeLight PRO II 980 mm
- Light: electric ballast, 18 Watt TC-L

Comprising:

- TSS column 445 system clamp 1
- TSS folding arm II
- OfficeLight PRO II



Colours	Art.No.	EAN Code
	220+0090+000	4009729046654



NOVUS Business Combination

- Optimal set for your notebook workstation
- Height of the column: 445 mm
- Mounting standard 75/100 mm
- Column attachment: system clamp 1, clamping length 14-40 mm
- Carrying capacity: monitor weight 7 kg / notebook weight 5 kg, infinitely variable height
- Range: TSS folding arm III 505 mm / TSS notebook holder 589 mm

Comprising:

- TSS column 445 system clamp 1
- TSS folding arm III
- TSS notebook holder

Colours	Art.No.	EAN Code
	220+0070+000	4009729046630

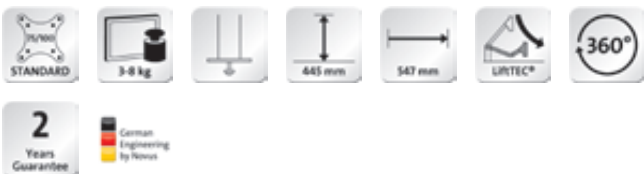

NOVUS Comfort Duo, with drilling screw fitting

- NOVUS LiftTEC the innovative support arm concept for ergonomics and special convenience
- Height of the column: 445 mm
- Mounting standard 75/100 mm
- Drilling screw fitting, desktop thickness 5-70 mm
- Carrying capacity: monitor weight 2 x 3-8 kg, infinitely variable height
- Action radius: 547 mm

Comprising:

- TSS column 445 with drilling screw fitting
- 2 x TSS-LiftTEC arm II

Colours	Art.No.	EAN Code
	220+0150+000	4009729046715



NOVUS TSS Duo

- Twin screen solution with the Novus Tetra-Support-System.
- Height of the column: 445 mm
- Mounting standard 75/100 mm
- Table mounting with system clamp 1 for a table thickness of 14-40 mm
- Total carrying capacity: 11 kg, evenly spread over all support arms, infinitely variable height
- Range: folding arm III 505 mm

Comprising:

- TSS column 445 system clamp 1
- 2 x TSS folding arm III



Colours	Art.No.	EAN Code
	220+0060+000	4009729046623



NOVUS TSS Trio

- Three screen solution for a much better productivity
- Height of the column: 445 mm
- Mounting standard 75/100 mm
- Drilling screw fitting HD, for desktop thickness 15-70 mm
- Total carrying capacity: 45 kg, evenly spread over all support arms, infinitely variable height
- Range: folding arm III XL 700 mm / support carriage 105 mm

Comprising:

- TSS column 445 drilling screw fitting HD
- 2 x TSS folding arm III XL 700
- TSS support carriage



Colours	Art.No.	EAN Code
	220+0180+000	4009729046746



NOVUS TSS Quattro

- Four flat screens no problem for the NOVUS Tetra-Support-System
- Height of the column: 845 mm
- Mounting standard 75/100 mm
- Drilling screw fitting HD, for desktop thickness 15-70 mm
- Total carrying capacity: 48 kg, evenly spread over all support arms, infinitely variable height
- Range: folding arm III 505 mm

Comprising:

- TSS column 845 drilling screw fitting HD
- 4 x TSS folding arm III

Colours	Art.No.	EAN Code
	220+0080+000	4009729046647



NOVUS Control Center

- Everything in view – the monitor bridge of the NOVUS Tetra-Support-System
- Height of the column: 445 mm
- Mounting standard 75/100 mm
- Table mounting with system clamp 1 for a table thickness of 14-40 mm
- Total carrying capacity: 22 kg, evenly spread over all support arms
- Range: TSS folding arm III 505 mm / SlatWall-LM-Arm 0-0-1 125 mm

Comprising:

- 2 x TSS column 445 system clamp 1
- SlatWall element 120
- 2 x TSS folding arm III
- 2 x SlatWall-LM arm 0-0-1

Colours	Art.No.	EAN Code
	220+0130+000	4009729046692



NOVUS Office Toolbar

- The talented organiser for the desktop with flat screen support and accessoires
- Height of the column: 250 mm
- Size SlatWall over the desk: 1600 x 250 mm
- Mounting standard 75/100 mm
- Column fixation with system clamp 1, clamping length 14-40mm
- Carrying capacity: monitor weight 3-8 kg, gas spring system for adjustable height
- Range: LiftTEC-Arm I 400 mm

Comprising:

- 2 x TSS column 250 system clamp 1
- SlatWall element 160
- Pura Line tray B4
- Pura Line pencil cup
- SlatWall-LiftTEC arm I

Colours	Art.No.	EAN Code
	220+0220+000	4009729054093



NOVUS Office Max

- Perfect solution the NOVUS SlatWall as organisation wall for modern workstations
- Height of the column: 445 mm
- Size SlatWall over the desk: 1000 x 445 mm
- Mounting standard 75/100 mm
- SlatWall attachment: system clamp 1, clamping length 14-40 mm
- Carrying capacity: monitor weight 3-8 kg, gas spring system for adjustable height
- Range: LiftTEC-Arm I 400 mm

Comprising:

- SlatWall 100
- SlatWall-LiftTEC arm I
- 2 x Perfora Line document tray B4
- Perfora Line pencil cup

Colours	Art.No.	EAN Code
	220+0160+000	4009729046722

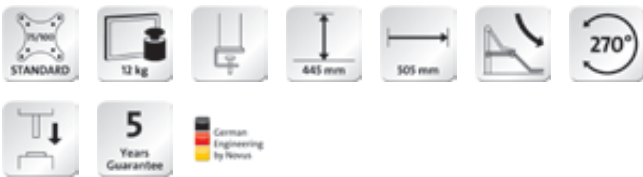

NOVUS Business & Light

- All-round package for desk organisation, lighting and flat screen
- Height of the column: 445 mm
- Size SlatWall over the desk: 1000 x 445 mm
- Mounting standard 75/100 mm
- Column attachment: system clamp 1, clamping length 14-40 mm
- Carrying capacity: monitor weight 12 kg, infinitely variable height
- Range: TSS folding arm III 505 mm / OfficeLight PRO II 980 mm
- Light: electric ballast, 18 Watt TC-L

Comprising:

- 2 x TSS column 445 system clamp 1
- OfficeLight PRO II
- SlatWall element 100
- TSS column adapter
- TSS folding arm III
- Pura Line pencil cup
- Pura Line tray B4

Colours	Art.No.	EAN Code
	220+0170+000	4009729046739



NOVUS Office Professional

- „All-rounder“ for two-screen workstations
- Height of the column: 445 mm
- Size SlatWall over the desk: 1000 x 445 mm
- Mounting standard 75/100 mm
- Column attachment: system clamp 1, clamping length 14-40 mm
- Total carrying capacity: 16 kg, evenly spread over all support arms
- Range: TSS folding arm III 505 mm / OfficeLight PRO II 980 mm
- Light: electric ballast, 18 Watt TC-L

Comprising::

- 2 x TSS column 445 system clamp 1
- 2 x SlatWall element 100
- OfficeLight PRO II
- TSS column adapter
- SlatWall-LM arm 0-0-1
- TSS folding arm III
- Pura Line tray B4

Colours	Art.No.	EAN Code
	220+0030+000	4009729046593



NOVUS Office Plus

- Elegant combination of monitor support, board and optimal work light
- Height of the column: 445 mm
- BoardMaster length: 1000 mm, compartment depth 195 mm
- Mounting standard 75/100 mm
- Column attachment: system clamp 1, clamping length 14-40 mm
- BoardMaster attachment: universal clamp 1, clamping length 18-74 mm
- Carrying capacity: monitor weight 10 kg, infinitely variable height
- Range: TSS-Faltarm II 450 mm / OfficeLight PRO II 980 mm
- Light: electric ballast, 18 Watt TC-L

Comprising:

- TSS column 445 system clamp 1
- TSS folding arm II
- BoardMaster 100
- OfficeLight PRO II

Colours	Art.No.	EAN Code
	220+0020+000	4009729046586



NOVUS TSS Wall Station

- Special applications demand special solutions - the NOVUS Tetra-Support-System for wall mounting.
- Length of the column: 890 mm.
- Mounting standard 75/100 mm
- Carrying capacity: monitor weight 15 kg, infinitely variable height
- Range: TSS-support carriage 105 mm / keyboard holder 528 mm

Comprising:

- TSS 890 wall rail
- TSS support carriage
- TSS keyboard holder

Colours	Art.No.	EAN Code
	220+0100+000	4009729046661



NOVUS Office Wall

- Functional wall solution for flat screen and paper management
- Height of the column: 445 mm
- SlatWall size: 1000 x 445 mm
- Mounting standard 75/100 mm
- Carrying capacity: monitor weight 10 kg, infinitely variable height
- Range: TSS-Faltarm II 450 mm

Comprising:

- 2 x TSS 445 wall rail
- 4 x SlatWall element 100
- TSS folding arm II
- 3 x Pura Line tray B4

Colours	Art.No.	EAN Code
	220+0120+000	4009729046685



NOVUS Business Board

- Systematic organisation the classics for storage and telephone
- BoardMaster length: 1000 mm, compartment depth 195 mm
- BoardMaster attachment: universal clamp 1, clamping length 18-74 mm
- Carrying capacity TalkMaster: telephone weight 2 kg
- Range: TalkMaster 700 mm

Comprising:

- BoardMaster 100
- TalkMaster
- CopySwinger III

Colours	Art.No.	EAN Code
	220+0140+000	4009729046708

Individually **combined**
in every **situation.**





Perfect support available everywhere for cutting-edge flat-screen monitors, laptops and tablet PCs – a customised and ergonomic solution.

Novus MY: solutions for greater style and efficiency at the workstation

Novus MY combines form, function and elegance to create attractive product solutions with a stylish look. The series offers perfect support arm solutions and holders for monitors, notebooks and tablet PCs. Their flexibility and mobility enable an ideal setup at every workstation.

Design and efficiency in pure form

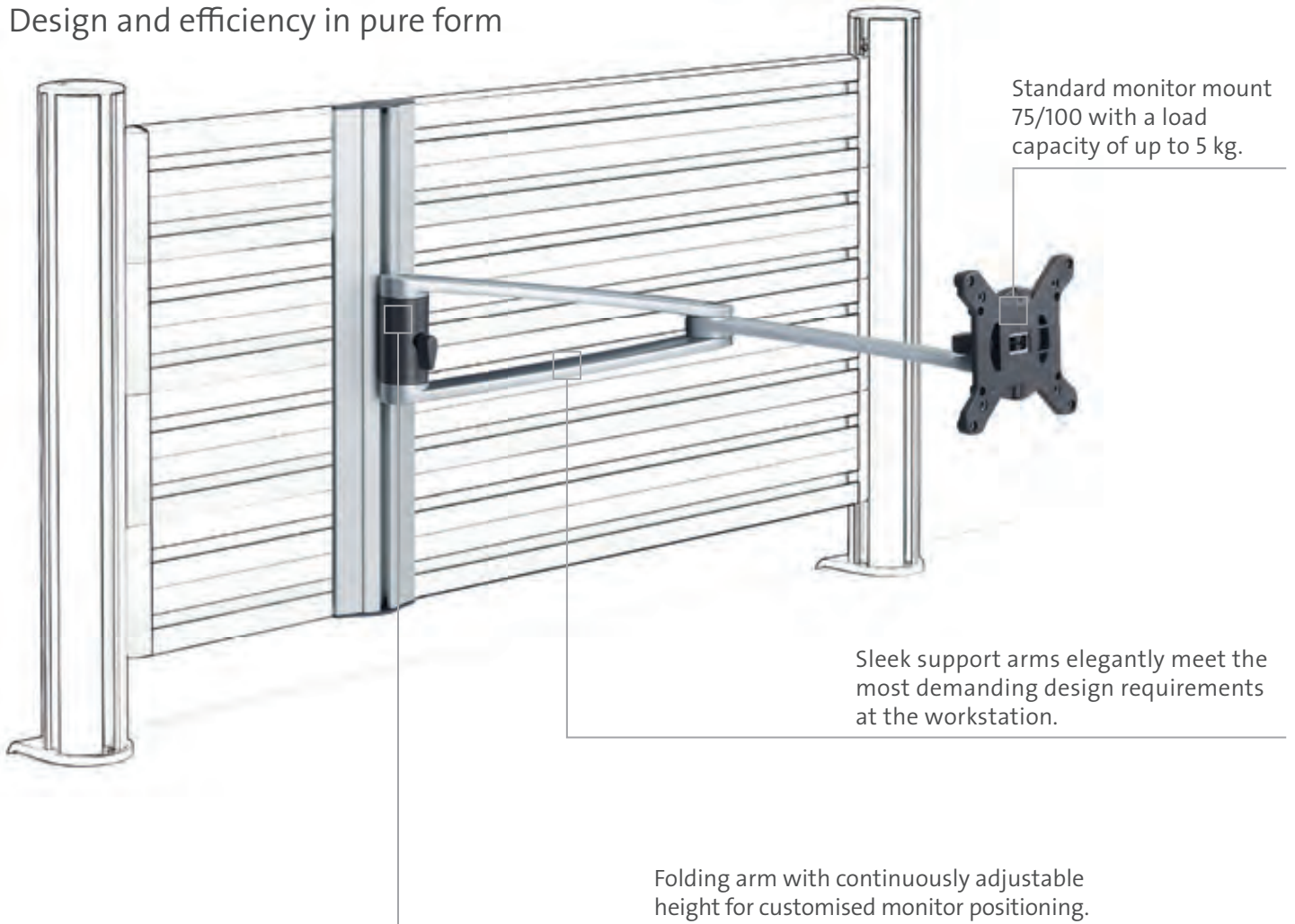

Suitable mounting

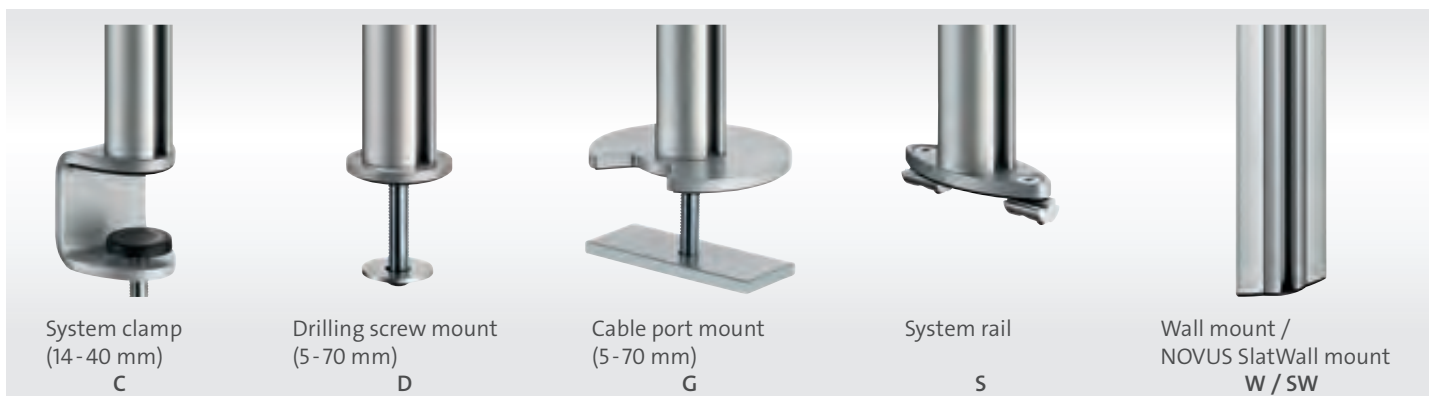

Flat-screen monitor holder – Novus MY

Smart combination

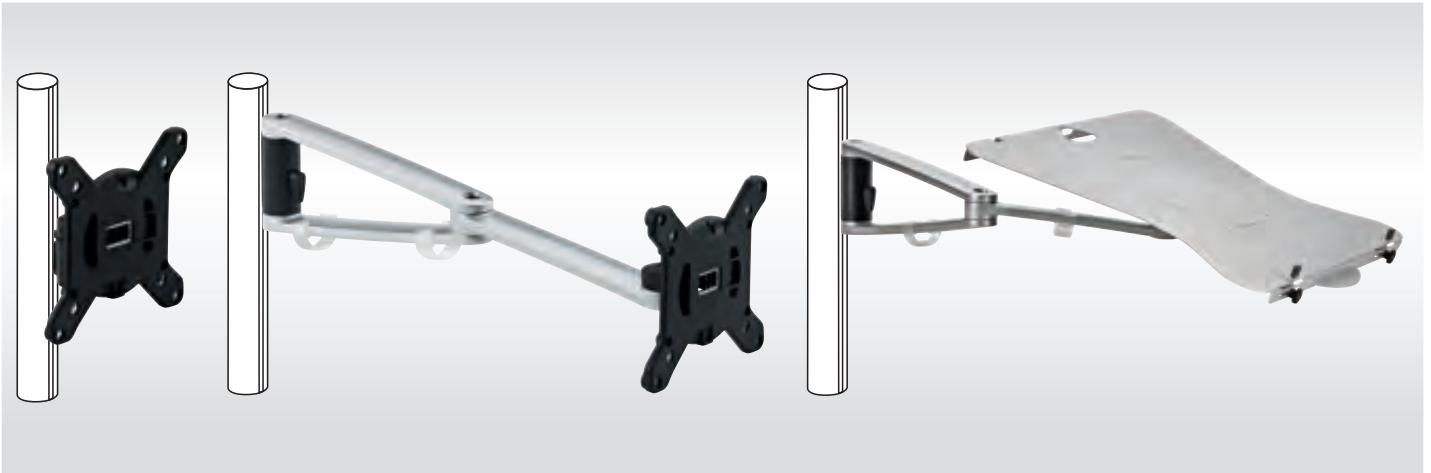

Support carriage / 2-part articulated arm / notebook holder: for precision customised adjustment of the desired monitor or notebook position.



Adapter plate makes it easy to change the monitor.



Tablet holder for tablets from 7" to 10" in size.



A perfect view, even with two monitors.







Suitable for connecting to an organisation wall.



NOVUS MY point

- Mobile tablet holder as the practical and modern basis for presentation and communication
- Universal stand for Tablets PC's with a size from 7" to 10" (clamping length 160-300 mm)
- Tablets can be used portrait or landscape format
- Anodised aluminium column with solid metal base
- Rotation and tilt is given by the cross joint for more mobility at limited space
- Infinitely height adjustable
- Height of the column: 250 mm
- Includes two cable clips







Colours	Art.No.	EAN Code
 	910+3099+000	4009729053874
 	910+3091+000	4009729053881



NOVUS MY one C, with system clamp

- Elegant monitor holder with infinitely height adjustable support carriage
- Combination of MY base and MY fix simple, efficient and elegant
- Table mounting with system clamp 1 for a table thickness of 14-40 mm
- Mounting standard 75/100 mm
- Mounting of flat screens up to 5 kg
- Rotation and tilt is given by the cross joint for more mobility at limited space
- Range: 50 mm
- Height of the column: 350 mm
- Includes two cable clips
- Combinable with NOVUS MY tab and NOVUS Quick Release



Colours	Art.No.	EAN Code
 	910+1019+000	4009729052099
 	910+1011+000	4009729053959







flat screen supports – Novus MY



NOVUS MY one D, with drilling screw fitting





- Elegant monitor holder with infinitely height adjustable support carriage
- Combination of MY base and MY fix simple, efficient and elegant
- Table mount with drilling screw fitting for a table thickness of 5-70 mm
- Mounting standard 75/100 mm
- Mounting of flat screens up to 5 kg
- Rotation and tilt is given by the cross joint for more mobility at limited space
- Range: 50 mm
- Height of the column: 350 mm
- Includes two cable clips
- Combinable with NOVUS MY tab and NOVUS Quick Release

Colours	Art.No.	EAN Code
 	910+1049+000	4009729052105
 	910+1041+000	4009729053966



NOVUS MY one G, with cable port attachment

- Elegant monitor holder with infinitely height adjustable support carriage
- Combination of MY base and MY fix simple, efficient and elegant
- Table mount with drilling screw fitting for a table thickness of 5-70 mm
- Mounting standard 75/100 mm
- Mounting of flat screens up to 5 kg
- Rotation and tilt is given by the cross joint for more mobility at limited space
- Range: 50 mm
- Height of the column: 350 mm
- Includes two cable clips
- Combinable with NOVUS MY tab and NOVUS Quick Release

Colours	Art.No.	EAN Code
 	910+1059+000	4009729052112
 	910+1051+000	4009729053973









NOVUS MY one S, with system rail mount

- Elegant monitor holder with infinitely height adjustable support carriage
- Combination of MY base and MY fix simple, efficient and elegant
- System rail mount for use in various system rails from the office furniture industry
- Mounting standard 75/100 mm
- Mounting of flat screens up to 5 kg
- Rotation and tilt is given by the cross joint for more mobility at limited space
- Range: 50 mm
- Height of the column: 350 mm
- Includes two cable clips
- Combinable with NOVUS MY tab and NOVUS Quick Release





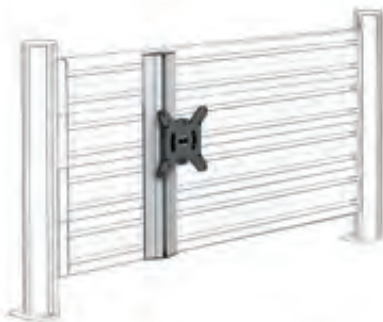

Colours	Art.No.	EAN Code
 	910+1069+000	4009729052129
 	910+1061+000	4009729053980



NOVUS MY one SW, with organisation wall mount

- Elegant monitor holder with infinitely height adjustable support carriage
- Combination of MY base and MY fix simple, efficient and elegant
- Adaption to the organisation wall via slot nuts
- Mounting standard 75/100 mm
- Mounting of flat screens up to 5 kg
- Rotation and tilt is given by the cross joint for more mobility at limited space
- Range: 50 mm
- Height of the column: 350 mm
- Combinable with NOVUS MY tab and NOVUS Quick Release







Colours	Art.No.	EAN Code
 	910+1079+000	4009729053454
 	910+1071+000	4009729053997

flat screen supports – Novus MY



NOVUS MY one W, with wall mount





- Elegant monitor holder with infinitely height adjustable support carriage
- Combination of MY base and MY fix simple, efficient and elegant
- Wall mounting with screws
- Mounting standard 75/100 mm
- Mounting of flat screens up to 5 kg
- Rotation and tilt is given by the cross joint for more mobility at limited space
- Range: 50 mm
- Height of the column: 350 mm
- Combinable with NOVUS MY tab and NOVUS Quick Release

Colours	Art.No.	EAN Code
 	910+1089+000	4009729053461
 	910+1081+000	4009729054000



NOVUS MY one plus C, with system clamp

- Elegant monitor holder with infinitely height adjustable folding arm
- Combination of MY base and MY arm for more design, flexibility and dynamics at the workplace
- Table mounting with system clamp 1 for a table thickness of 14-40 mm
- Mounting standard 75/100 mm
- Mounting of flat screens up to 5 kg
- Range: 415 mm
- Monitor arm infinitely adjustable in height, tilt and rotation
- Height of the column: 350 mm
- Supplied with cable clips
- Combinable with NOVUS MY tab and NOVUS Quick Release





Colours	Art.No.	EAN Code
 	910+2019+000	4009729052051
 	910+2011+000	4009729053898



NOVUS MY one plus D, with drilling screw fitting

- Elegant monitor holder with infinitely height adjustable folding arm
- Combination of MY base and MY arm for more design, flexibility and dynamics at the workplace
- Table mount with drilling screw fitting for a table thickness of 5-70 mm
- Mounting standard 75/100 mm
- Mounting of flat screens up to 5 kg
- Range: 415 mm
- Monitor arm infinitely adjustable in height, tilt and rotation
- Height of the column: 350 mm
- Supplied with cable clips
- Combinable with NOVUS MY tab and NOVUS Quick Release







Colours	Art.No.	EAN Code
 	910+2049+000	4009729052068
 	910+2041+000	4009729053904



NOVUS MY one plus G, with cable port attachment

- Elegant monitor holder with infinitely height adjustable folding arm
- Combination of MY base and MY arm for more design, flexibility and dynamics at the workplace
- Table mount with cable port attachment for a table thickness of 5-70 mm
- Mounting standard 75/100 mm
- Mounting of flat screens up to 5 kg
- Range: 415 mm
- Monitor arm infinitely adjustable in height, tilt and rotation
- Height of the column: 350 mm
- Supplied with cable clips
- Combinable with NOVUS MY tab and NOVUS Quick Release







Colours	Art.No.	EAN Code
 	910+2059+000	4009729052075
 	910+2051+000	4009729053911

flat screen supports – Novus MY



NOVUS MY one plus S, with system rail mount





- Elegant monitor holder with infinitely height adjustable folding arm
- Combination of MY base and MY arm for more design, flexibility and dynamics at the workplace
- System rail mount for use in various system rails from the office furniture industry
- Mounting standard 75/100 mm
- Mounting of flat screens up to 5 kg
- Range: 415 mm
- Monitor arm infinitely adjustable in height, tilt and rotation
- Height of the column: 350 mm
- Supplied with cable clips
- Combinable with NOVUS MY tab and NOVUS Quick Release

Colours	Art.No.	EAN Code
 	910+2069+000	4009729052082
 	910+2061+000	4009729053928



NOVUS MY one plus SW, with organisation wall mount

- Elegant monitor holder with infinitely height adjustable folding arm
- Combination of MY base and MY arm for more design, flexibility and dynamics at the workplace
- Adaption to the organisation wall via slot nuts
- Mounting standard 75/100 mm
- Mounting of flat screens up to 5 kg
- Range: 415 mm
- Monitor arm infinitely adjustable in height, tilt and rotation
- Height of the column: 350 mm
- Supplied with cable clips
- Combinable with NOVUS MY tab and NOVUS Quick Release





Colours	Art.No.	EAN Code
 	910+2079+000	4009729053478
 	910+2071+000	4009729053935



NOVUS MY one plus W, with wall mount

- Elegant monitor holder with infinitely height adjustable folding arm
- Combination of MY base and MY arm for more design, flexibility and dynamics at the workplace
- Wall mounting with screws
- Mounting standard 75/100 mm
- Mounting of flat screens up to 5 kg
- Range: 415 mm
- Monitor arm infinitely adjustable in height, tilt and rotation
- Height of the column: 350 mm
- Combinable with NOVUS MY tab and NOVUS Quick Release





Colours	Art.No.	EAN Code
 	910+2089+000	4009729053485
 	910+2081+000	4009729053942



NOVUS MY twin fix C, with system clamp

- Elegant monitor holder with two support carriages infinitely adjustable in height
- Combination of MY base and MY fix functional and well designed for the attachment of two opposite monitors
- Table mounting with system clamp 1 for a table thickness of 14-40 mm
- Mounting standard 75/100 mm
- Mounting of two flat screens up to 5 kg
- Rotation and tilt is given by the cross joint for more mobility at limited space
- Range: 50 mm
- Height of the column: 350 mm
- Supplied with cable clips
- Combinable with NOVUS MY tab and NOVUS Quick Release





Colours	Art.No.	EAN Code
 	910+1119+000	4009729052174

flat screen supports – Novus MY



NOVUS MY twin fix D, with drilling screw fitting



- Elegant monitor holder with two support carriages infinitely adjustable in height
- Combination of MY base and MY fix functional and well designed for the attachment of two opposite monitors
- Table mount with drilling screw fitting for a table thickness of 5-70 mm
- Mounting standard 75/100 mm
- Mounting of two flat screens up to 5 kg
- Rotation and tilt is given by the cross joint for more mobility at limited space
- Range: 50 mm
- Height of the column: 350 mm
- Supplied with cable clips
- Combinable with NOVUS MY tab and NOVUS Quick Release

Colours	Art.No.	EAN Code
 	910+1149+000	4009729052181



NOVUS MY twin fix G, with cable port attachment



- Elegant monitor holder with two support carriages infinitely adjustable in height
- Combination of MY base and MY fix functional and well designed for the attachment of two opposite monitors
- Table mount with cable port attachment for a table thickness of 5-70 mm
- Mounting standard 75/100 mm
- Mounting of two flat screens up to 5 kg
- Rotation and tilt is given by the cross joint for more mobility at limited space
- Range: 50 mm
- Height of the column: 350 mm
- Supplied with cable clips
- Combinable with NOVUS MY tab and NOVUS Quick Release

Colours	Art.No.	EAN Code
 	910+1159+000	4009729052198



NOVUS MY twin fix S, with system rail mount



- Elegant monitor holder with two support carriages infinitely adjustable in height
- Combination of MY base and MY fix functional and well designed for the attachment of two opposite monitors
- System rail mount for use in various system rails from the office furniture industry
- Mounting standard 75/100 mm
- Mounting of two flat screens up to 5 kg
- Rotation and tilt is given by the cross joint for more mobility at limited space
- Range: 50 mm
- Height of the column: 350 mm
- Supplied with cable clips
- Combinable with NOVUS MY tab and NOVUS Quick Release

Colours	Art.No.	EAN Code
 	910+1169+000	4009729052204



NOVUS MY twin arm C, with system clamp

- Elegant monitor holder with two infinitely height adjustable folding arms
- Combination of MY base and two MY arm attractive appearance with maximum flexibility in the positioning of two monitors
- Table mounting with system clamp 1 for a table thickness of 14-40 mm
- Mounting standard 75/100 mm
- Mounting of two flat screens up to 5 kg
- Range: 415 mm
- Monitor arm infinitely adjustable in height, tilt and rotation
- Height of the column: 350 mm
- Supplied with cable clips
- Combinable with NOVUS MY tab and NOVUS Quick Release



Colours	Art.No.	EAN Code
 	910+2219+000	4009729052136

flat screen supports – Novus MY



NOVUS MY twin arm D, with drilling screw fitting



- Elegant monitor holder with two infinitely height adjustable folding arms
- Combination of MY base and two MY arm attractive appearance with maximum flexibility in the positioning of two monitors
- Table mount with drilling screw fitting for a table thickness of 5-70 mm
- Mounting standard 75/100 mm
- Mounting of two flat screens up to 5 kg
- Range: 415 mm
- Monitor arm infinitely adjustable in height, tilt and rotation
- Height of the column: 350 mm
- Supplied with cable clips
- Combinable with NOVUS MY tab and NOVUS Quick Release

Colours	Art.No.	EAN Code
 	910+2249+000	4009729052143



NOVUS MY twin arm G, with cable port attachment

- Elegant monitor holder with two infinitely height adjustable folding arms
- Combination of MY base and two MY arm attractive appearance with maximum flexibility in the positioning of two monitors
- Table mount with cable port attachment for a table thickness of 5-70 mm
- Mounting standard 75/100 mm
- Mounting of two flat screens up to 5 kg
- Range: 415 mm
- Monitor arm infinitely adjustable in height, tilt and rotation
- Height of the column: 350 mm
- Supplied with cable clips
- Combinable with NOVUS MY tab and NOVUS Quick Release



Colours	Art.No.	EAN Code
 	910+2259+000	4009729052150



NOVUS MY twin arm S, with system rail mount

- Elegant monitor holder with two infinitely height adjustable folding arms
- Combination of MY base and two MY arm attractive appearance with maximum flexibility in the positioning of two monitors
- System rail mount for use in various system rails from the office furniture industry
- Mounting standard 75/100 mm
- Mounting of two flat screens up to 5 kg
- Range: 415 mm
- Monitor arm infinitely adjustable in height, tilt and rotation
- Height of the column: 350 mm
- Supplied with cable clips
- Combinable with NOVUS MY tab and NOVUS Quick Release









Colours	Art.No.	EAN Code
 	910+2269+000	4009729052167



NOVUS MY base W, wall rail

- Wall mounting with screws
- Flat distance to the wall of about 20 mm
- Available in length: 350 mm, 450 mm and 890 mm
- Covered screw holes
- Customised length on request



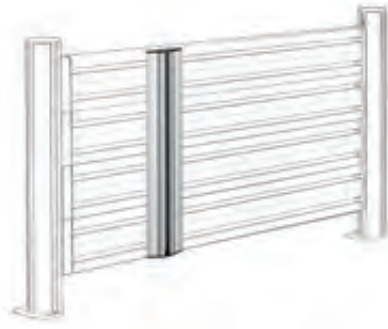

Colours	Art.No.	EAN Code
 	911+0089+000	4009729052952
 	911+0189+000	4009729053355
 	911+0289+000	4009729053362

flat screen supports – Novus MY



NOVUS MY base SW, organisation wall mount



- Aluminium profile for mounting on an organisation wall
- Adaption to the organisation wall via slot nuts
- Flat distance to the organisation wall of about 20 mm
- Height of the column: 350 mm
- Covered screw holes
- Fastening material included

Colours	Art.No.	EAN Code
 	911+0079+000	4009729052945



NOVUS MY fix

- Infinitely height adjustable support carriage with mounting standard 75/100
- Mounting of flat screens up to 5 kg
- Rotation and tilt is given by the cross joint for more mobility at limited space
- Range: 50 mm
- Balance mechanism at the front joint for optimum monitor positioning
- MY base as a mandatory extension

Colours	Art.No.	EAN Code
	911+1001+000	4009729053751
	911+1009+000	4009729052013





NOVUS MY arm

- Infinitely height adjustable 2-part articulated arm with standard mounting 75/100
- Mounting of flat screens up to 5 kg
- Swivelling and tiltable
- Range: 415 mm
- Balance mechanism at the front joint for optimum monitor positioning
- Enables horizontal positioning of the screen
- Includes two cable clips
- MY base or TSS column as a mandatory extension



Colours	Art.No.	EAN Code
	911+2001+000	4009729053768
	911+2009+000	4009729052037



NOVUS MY notebookarm

- High quality notebook holder with 2-part aluminium arm, infinitely adjustable
- Support platform (404 x 288 mm) for regular and large notebooks
- Carrying capacity 5 kg
- Turn- and tiltable up to 45°
- Grommet in the support plate
- MY base or TSS column as a mandatory extension



Colours	Art.No.	EAN Code
	911+4009+000	4009729055359



NOVUS MY tab

- Unique tablet holder that makes it very easy to insert and remove a variety of tablets
- Tablet mount for tablets with a size of 7" to 10" (clamping length 160-300 mm)
- Tablets can be used portrait or landscape format
- For attachment to NOVUS MY fix, NOVUS MY arm and NOVUS TSS support elements



Colours	Art.No.	EAN Code
	911+3001+000	4009729053775
	911+3005+000	4009729052525

flat screen supports – Novus MY



NOVUS QuickRelease





- Quick release system for NOVUS MY fix and NOVUS MY arm and other NOVUS support elements
- Enables quick and easy monitor change without tools

Colours	Art.No.	EAN Code
	795+9095+000	4009729052860



NOVUS MY Toolbar

- SlatWall element with two slots for attaching accessories monitor arms and Attenzia lights
- Mounted with twin MY base C 250 mm
- Desktop mount with system clamp 1 (MY Clamp 14-40 mm)
- Available in length: 1200 mm, 1600 mm

Colours	Art.No.	EAN Code
 	915+1209+000	4009729062234
 	915+1609+000	4009729062241



Novus Tetra Support System: reliable solutions to meet the highest demands

The cutting-edge flat-screen monitor holders in the Novus Tetra Support System provide monitors with new-found mobility. Whether in the office or in the control centre, the Tetra Support System has a secure and flexible monitor mount to suit every workstation. With a range of combination options to choose from, flexibility takes on a whole new meaning.

A product range that responds to individual customer requirements.

Sophisticated functionality: Novus TSS monitor support arms

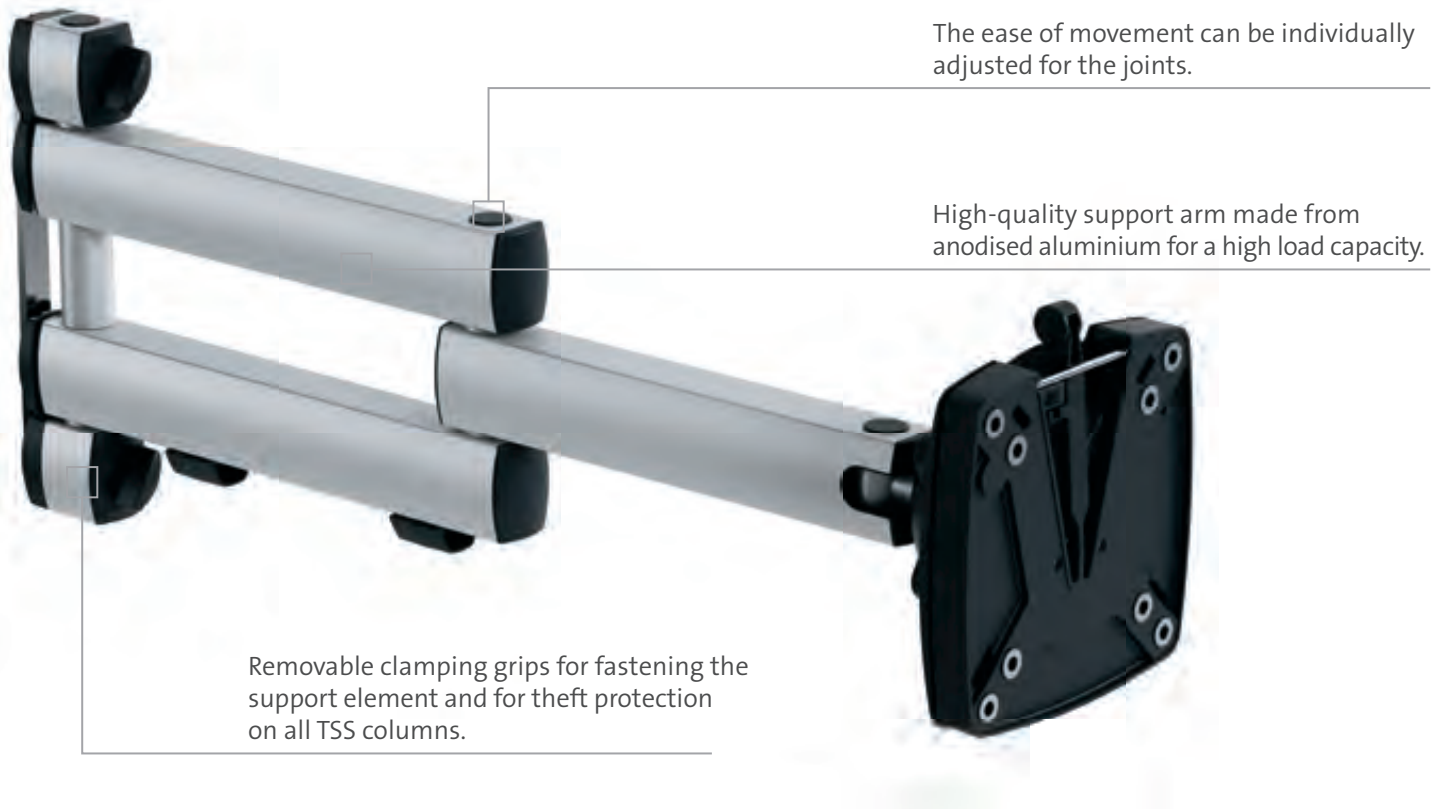

Mounts for every workstation



Flat-screen monitor holder – Novus Tetra-Support-System

Flexible combination of all components

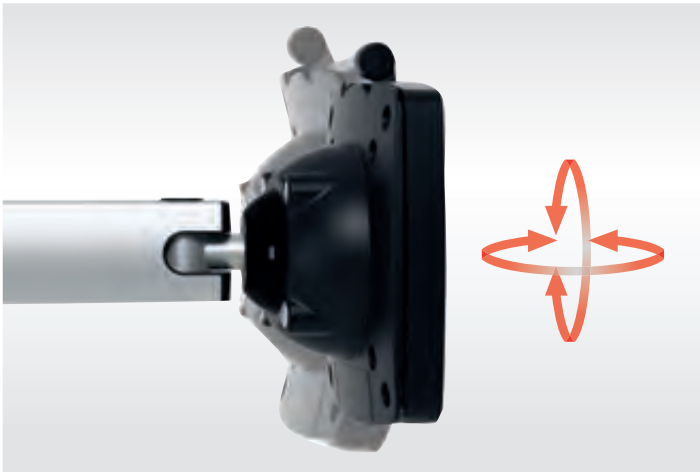

Ball-and-socket joint for flexible and precise positioning of the monitor.



NOVUS QuickRelease makes it quick and easy to change the monitor without any tools.

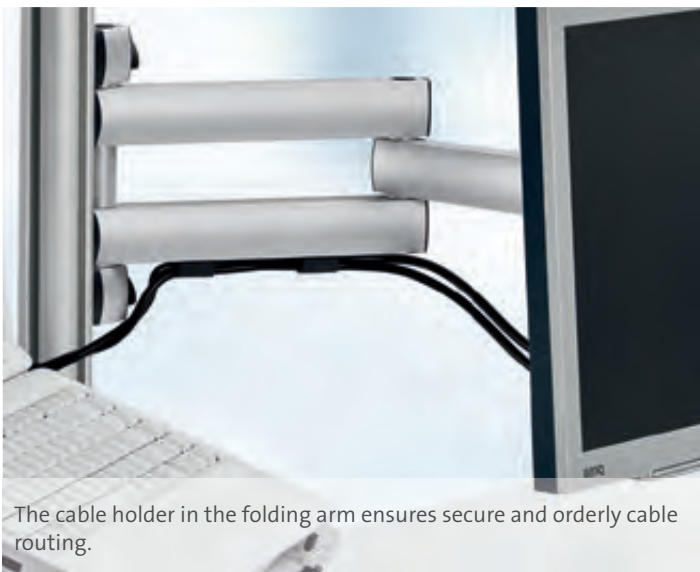

The cable holder in the folding arm ensures secure and orderly cable routing.

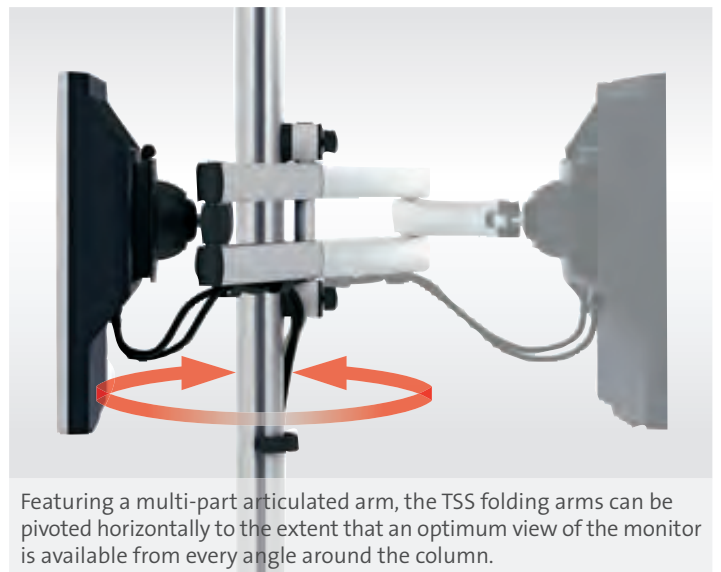



Featuring a multi-part articulated arm, the TSS folding arms can be pivoted horizontally to the extent that an optimum view of the monitor is available from every angle around the column.



NOVUS TSS column with support foot





- Aluminium column with four slots and base
- Solid base weighing 4 kg with rubber pads to protect the desk surface and for stability
- Available in length: 445 mm
- Includes two cable clips
- For TSS support carriage

Colours	Art.No.	EAN Code
 	961+0309+000	4009729030585



NOVUS TSS column with system clamp 1 (14-40mm)

- Aluminium column with four slots and system clamp 1
- Table mounting with system clamp 1 for a desktop thickness of 14-40 mm
- Available in length: 445 mm and 545 mm
- Includes two cable clips
- Suitable for all TSS support elements

Colours	Art.No.	EAN Code
 	961+0609+000	4009729033661
 	961+0639+000	4009729042151





flat screen supports – Novus Tetra-Support-System



NOVUS TSS column with system clamp 1 (13-25 mm)





- Aluminium column with four slots and system clamp 1
- Table mounting with system clamp 1 for a desktop thickness of 13-25 mm, ideal for mounting on sliding tabletops
- Available in length: 445 mm
- Includes two cable clips
- Suitable for all TSS support elements

Colours	Art.No.	EAN Code
 	961+2709+000	4009729045015



NOVUS TSS column with system clamp 2







- Aluminium column with four slots and system clamp 2
- Table mounting with system clamp 2 for a desktop thickness of 5-70 mm
- Available in length: 445 mm and 545 mm
- Includes two cable clips
- Suitable for all TSS support elements

Colours	Art.No.	EAN Code
 	961+0209+000	4009729027974
 	961+0239+000	4009729042168







NOVUS TSS column with drilling screw fitting

- Aluminium column with four slots and drilling screw fitting
- Table mount with drilling screw fitting for a desktop thickness of 5-70 mm
- Available in length: 445 mm, 545 mm and 845 mm
- Includes two cable clips
- Suitable for all TSS support elements

Colours	Art.No.	EAN Code
 	961+0109+000	4009729027950
 	961+0139+000	4009729042182
 	961+0119+000	4009729027967







NOVUS TSS column with drilling screw fitting HD

- Aluminium column with four slots and heavy duty drilling screw mounting
- Drilling screw fitting HD, for desktop thickness 15-70 mm
- Available in length: 445 mm and 845 mm
- Includes two cable clips
- Suitable for all TSS support elements

Colours	Art.No.	EAN Code
 	961+1809+000	4009729050408
 	961+1819+000	4009729050422

NOVUS TSS column with cable port fitting

- Aluminium column with four slots and cable port attachment
- Table mount with cable port attachment for a desktop thickness of 5-70 mm
- Available in length: 445 mm, 545 mm and 845 mm
- Includes two cable clips
- Suitable for all TSS support elements

Colours	Art.No.	EAN Code
 	961+0409+000	4009729033333
 	961+0439+000	4009729042175
 	961+0419+000	4009729033456





flat screen supports – Novus Tetra-Support-System



NOVUS TSS column with location pin adaption



- Aluminium column with four slots and pin adapter
- Table mount with pin adapter (diameter 16 mm) for use in various table adapters of the office furniture industry
- Height of the column: 445 mm
- Includes two cable clips
- Suitable for all TSS support elements

Colours	Art.No.	EAN Code
 	961+2509+000	4009729045008



NOVUS TSS column with system rail mounting





- Aluminium column with four slots and system rail attachment
- System rail mount for use in various system rails from the office furniture industry
- Available in length: 445 mm
- Includes two slot nuts and two cable clips
- Suitable for all TSS support elements

Colours	Art.No.	EAN Code
 	961+2309+000	4009729044995



NOVUS TSS wall rail

- Aluminium column (depth of 38,5 mm) with three slots for wall
- Wall mounting with screws
- Available in length: 445 mm and 890 mm
- Width of the column: 51 mm
- Includes two cable clips
- Can be combined with SlatWall elements
- Suitable for all TSS support elements



Colours	Art.No.	EAN Code
 	961+0509+000	4009729033463
 	961+0519+000	4009729033470





NOVUS TSS column with ceiling mount



- Aluminium column with four slots and ceiling mount
- For mounting at the ceiling, depending on ceiling texture
- Height of the column: 845 mm
- Includes two cable clips
- Suitable for all TSS support elements

Colours	Art.No.	EAN Code
 	961+0819+000	4009729042144



NOVUS TSS column with floor-ceiling mount

- Aluminium column with four slots and ceiling/floor mount
- For mounting between the ceiling and floor, depending on the ceiling and floor texture
- Special dimensions on request (maximum 300 mm)
- Including mounts, the column has a length of 2500mm, with length compensation from -15 to +15 mm
- Includes two cable clips
- Suitable for all TSS support elements

Colours	Art.No.	EAN Code
 	961+0949+000	4009729044254



NOVUS TSS support carriage 32

- High quality infinitely height adjustable support carriage
- Suitable for mounting standards: 100x100 and 200x100
- Mounting of flat screens up to 20 kg
- Restrict movement by tightening the joints
- Turnable for movement on limited space
- Range: 64 mm
- In high-quality aluminium and metal
- Supplied with fixing screws M5 and M6
- Obligatory supplement is a TSS column

Colours	Art.No.	EAN Code
	963+0029+001	4009729044230



flat screen supports – Novus Tetra-Support-System



NOVUS TSS supporting arm 32

- High quality infinitely height adjustable support arm
- Suitable for mounting standards: 100x100 and 200x100
- Mounting of flat screens up to 20 kg
- Restrict movement by tightening the joints
- Swivelling and tiltable
- Range: 187 mm
- In high-quality aluminium and metal
- Supplied with fixing screws M5 and M6
- Obligatory supplement is a TSS column

Colours	Art.No.	EAN Code
	962+0029+000	4009729044223



NOVUS TSS support carriage

- High quality infinitely height adjustable support carriage
- Easy mounting of the monitor by quick release with one hand operation, suitable for mounting standard 75/100
- Mounting of flat screens up to 15 kg
- Restrict movement by tightening the joints
- Swivelling and tiltable
- Range: 105 mm
- Removable clamping grips for protection from theft
- Obligatory supplement is a TSS column

Colours	Art.No.	EAN Code
	963+0119+000	4009729047002



NOVUS TSS support arm

- High quality infinitely height adjustable 1-part monitor support arm
- Easy mounting of the monitor by quick release with one hand operation, suitable for mounting standard 75/100
- Mounting of flat screens up to 15 kg
- Restrict movement by tightening the joints
- Easy monitor adjustment by different joints
- Range: 250 mm
- Perfect cable management by cable clips
- Removable clamping grips for protection from theft
- Obligatory supplement is a TSS column

Colours	Art.No.	EAN Code
	962+0119+000	4009729046999



NOVUS TSS support arm XL

- High quality infinitely height adjustable 1-part monitor support arm
- Easy mounting of the monitor by quick release with one hand operation, suitable for mounting standard 75/100
- Mounting of flat screens up to 15 kg
- Restrict movement by tightening the joints
- Easy monitor adjustment by different joints
- Range: 325 mm
- Perfect cable management by cable clips
- Removable clamping grips for protection from theft
- Obligatory supplement is a TSS column



Colours	Art.No.	EAN Code
	962+0119+001	4009729051528



NOVUS TSS folding arm II

- High quality infinitely height adjustable 2-part monitor support arm
- Easy mounting of the monitor by quick release with one hand operation, suitable for mounting standard 75/100
- Mounting of flat screens up to 10 kg
- Restrict movement by tightening the joints
- Ergonomic monitor setting by various joints
- Range: 450 mm
- Perfect cable management by cable clips
- Removable clamping grips for protection from theft
- Obligatory supplement is a TSS column



Colours	Art.No.	EAN Code
	964+0119+000	4009729046982

flat screen supports – Novus Tetra-Support-System



NOVUS TSS folding arm III

- High quality 2-part articulated arm, infinitely height adjustable
- Easy mounting of the monitor by quick release with one hand operation, suitable for mounting standard 75/100
- Mounting of flat screens up to 15 kg
- Restrict movement by tightening the joints
- Ergonomic monitor setting by various joints
- Range: 505 mm
- Perfect cable management by cable clips
- Removable clamping grips for protection from theft
- Obligatory supplement is a TSS column

Colours	Art.No.	EAN Code
	965+0119+000	4009729046975

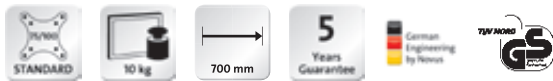

NOVUS TSS folding arm III XL (700)

- High quality 2-part articulated arm, infinitely height adjustable
- Easy mounting of the monitor by quick release with one hand operation, suitable for mounting standard 75/100
- Mounting of flat screens up to 10 kg
- Restrict movement by tightening the joints
- Ergonomic monitor setting by various joints
- Range: 700 mm
- Perfect cable management by cable clips
- Removable clamping grips for protection from theft
- Obligatory supplement is a TSS column

Colours	Art.No.	EAN Code
	965+0119+001	4009729047514



NOVUS TSS folding arm III XL (800)

- High quality 2-part articulated arm, infinitely height adjustable
- Easy mounting of the monitor by quick release with one hand operation, suitable for mounting standard 75/100
- Mounting of flat screens up to 10 kg
- Restrict movement by tightening the joints
- Ergonomic monitor setting by various joints
- Range: 800 mm
- Perfect cable management by cable clips
- Removable clamping grips for protection from theft
- Obligatory supplement is a TSS column

Colours	Art.No.	EAN Code
	965+0119+003	4009729047521



NOVUS TSS folding arm III XL (900)

- High quality 2-part articulated arm, infinitely height adjustable
- Easy mounting of the monitor by quick release with one hand operation, suitable for mounting standard 75/100
- Mounting of flat screens up to 10 kg
- Restrict movement by tightening the joints
- Ergonomic monitor setting by various joints
- Range: 900 mm
- Perfect cable management by cable clips
- Removable clamping grips for protection from theft
- Obligatory supplement is a TSS column

Colours	Art.No.	EAN Code
	965+0119+004	4009729047538



NOVUS TSS telescope arm III

- High quality aluminium finish with anodised surfaces
- Easy mounting of the monitor by quick release with one hand operation, suitable for mounting standard 75/100
- Mounting of flat screens up to 10 kg
- Easy monitor adjustment by different joints and telescopic sliding mechanism
- Range: 314 - 400 mm
- Perfect cable management by cable clips
- Removable clamping grips for protection from theft
- Obligatory supplement is a TSS column

Colours	Art.No.	EAN Code
	968+0119+000	4009729061992

flat screen supports – Novus Tetra-Support-System



NOVUS TSS notebook holder

- High quality notebook holder with 2-part aluminium arm, infinitely adjustable
- Support platform (404 x 288 mm) for regular and large notebooks
- Carrying capacity up to 10 kg
- Turn- and tiltable up to 25°
- Range: 589 mm
- Grommet in the support plate
- Removable clamping grips for protection from theft and cable holder
- Obligatory supplement is a TSS column

Colours	Art.No.	EAN Code
	966+0119+000	4009729047156



NOVUS TSS keyboard holder

- High quality keyboard holder with 2-part aluminium arm, infinitely adjustable
- Support platform for computer keyboard and mouse (640 x 172 mm)
- Restrict movement by tightening the joints
- Turn- and tiltable up to 25°
- Range: 528 mm
- Removable clamping grips for protection from theft and cable holder
- Obligatory supplement is a TSS column

Colours	Art.No.	EAN Code
	967+0119+000	4009729047163



NOVUS TSS keyboard holder XL

- High quality keyboard holder with 2-part aluminium arm, infinitely adjustable
- Support platform for computer keyboard and mouse (640 x 172 mm)
- Restrict movement by tightening the joints
- Turn- and tiltable up to 25°
- Range: 728 mm
- Removable clamping grips for protection from theft and cable holder
- Obligatory supplement is a TSS column

Colours	Art.No.	EAN Code
	967+0119+001	4009729051757



NOVUS TSS keyboard adapter

- Practical keyboard adapter for mounting between support element and monitor
- Support platform for computer keyboard and mouse (640 x 172 mm)
- Range: 276 mm
- Practical cable clips route the cables for keyboard and mouse along the centre
- Including two cable clips for optimal cable management directly to the column
- To be used with NOVUS TSS monitor arms

Colours	Art.No.	EAN Code
	795+9159+000	4009729054345



NOVUS Thin Client holder







- Holder for Thin Clients of 35 to 53 mm in width
- The holder can be infinitely adjusted to the width of the Thin Client
- Suitable for attachment to a column, to an organisation wall or directly between a support element and a monitor
- Mounting standard 100x100
- Carrying capacity: Thin Client weight 7,5 kg

Colours	Art.No.	EAN Code
	795+9085+000	4009729058381



NOVUS Cover Strips

- Cover strips for TSS slots, for hygienic and easy surface cleaning
- Available as pack of four
- Available in length: 445 mm, 545 mm and 845 mm
- Suitable for all TSS columns in standard lengths

Colours	Art.No.	EAN Code
 	795+4458+000	4009729051665
 	795+5458+000	4009729051672
 	795+8458+000	4009729051689



flat screen supports – Novus Tetra-Support-System



NOVUS drop guard

- Prevents monitor arms from slipping off
- Can also be used as anti-theft device

Colours	Art.No.	EAN Code
	795+9100+000	4009729033012



NOVUS TSS cable clip set

- Clips for cable management directly at the column
- Available as pack of two







Colours	Art.No.	EAN Code
	961+0005+000	4009729031391



NOVUS SlatWall

- Organisation wall for a perfectly organised workspace
- Consisting of: four SlatWall elements, two TSS-445 columns with system clamp 1
- The individual elements can be mounted in varying numbers and positions
- Available in length: 800 mm, 1000 mm and 1200 mm (incl. TSS columns)
- Combinable with monitor support arms, SlatWall boards and accessories from the series Pura Line











Colours	Art.No.	EAN Code
 	974+0805+000	4009729035795
 	974+1005+000	4009729035504
 	974+1205+000	4009729035771



NOVUS SlatWall element





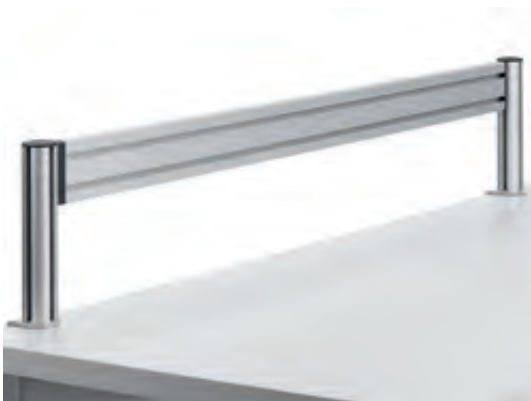

- Element can be combined with an TSS column for a perfectly organised workspace
- Available in lengths: 800 mm, 1000 mm, 1200 mm & 1600 mm (outer measurements incl. TSS columns)
- Combinable with monitor support arms, SlatWall boards and accessories from the series Pura Line

Colours	Art.No.	EAN Code
 	973+0805+000	4009729034941
 	973+1005+000	4009729034958
 	973+1205+000	4009729035764
 	973+1605+000	4009729052518



NOVUS TSS Toolbar

- SlatWall element with two slots for attaching accessories, monitor arms and office lights
- Mounted with two TSS columns 250 mm
- Table mounting with system clamp 1
- Available in length: 1200 mm, 1400 mm & 1600 mm

Colours	Art.No.	EAN Code
 	975+1209+000	4009729052877
 	975+1409+000	4009729052884
 	975+1609+000	4009729052891

flat screen supports – Novus Tetra-Support-System



NOVUS SlatWall Cable clip

- Cable clip for optimal cable management at SlatWall
- Available as pack of three



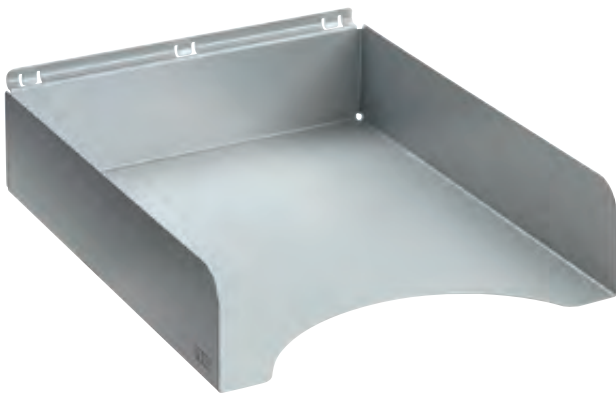

Colours	Art.No.	EAN Code
	796+0005+000	4009729041543

2
Years
Guarantee



NOVUS Pura Line tray B4

- High quality tray for documents in sizes up to DIN B4, available in two sizes
- Dimensions of portrait format: W 248 mm, H 64 mm, D 330 mm; dimensions of landscape format: W 330 mm, H 64 mm, D 248 mm
- In high-quality metal with powder-coated finish
- Obligatory supplement is a SlatWall element

Colours	Art.No.	EAN Code
 	723+0019+000	4009729035962
 	723+0029+000	4009729035979



5
Years
Guarantee



NOVUS Pura Line pencil cup

- Taking up very little space on the SlatWall, the pencil cup keeps everything neat and tidy
- In high-quality metal with powder-coated finish
- Dimensions: W 85 mm, H 84 mm, D 86 mm
- Obligatory supplement is a SlatWall element

Colours	Art.No.	EAN Code
	723+0069+000	4009729036013



2
Years
Guarantee

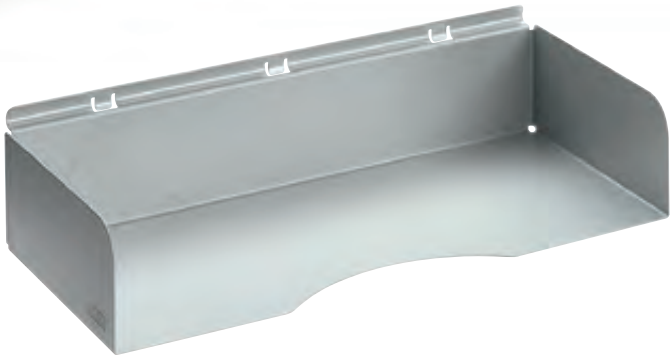



NOVUS Pura Line multi-purpose box

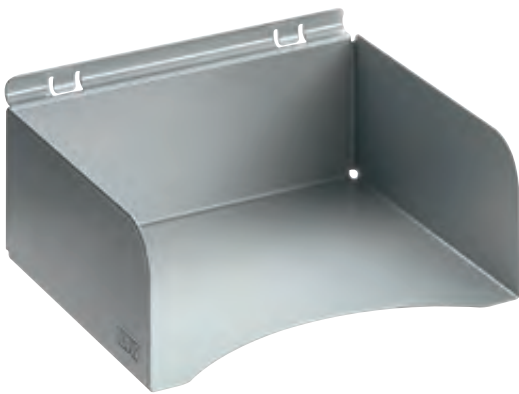

- High quality multi purpose box, available in two sizes
- Dimensions: W 330 mm, H 64 mm, D 146 mm
- In high-quality metal with powder-coated finish
- Obligatory supplement is a SlatWall element

Colours	Art.No.	EAN Code
 	723+0059+000	4009729036006



NOVUS Pura Line multi-purpose box small







- High quality multi purpose box, available in two sizes
- Dimensions: W 164 mm, H 83 mm, D 146 mm
- In high-quality metal with powder-coated finish
- Obligatory supplement is a SlatWall element

Colours	Art.No.	EAN Code
 	723+0049+000	4009729035993



NOVUS SlatWall-board

- Elegant filing board for files, books and other office utensils with a large surface thanks depth of 302 mm
- Practical, infinitely adjustable side supports
- Available in length: 600 mm, 800 mm and 1000 mm
- Obligatory supplement is a SlatWall element

Colours	Art.No.	EAN Code
 	760+0605+000	4009729040300
 	760+0805+000	4009729029466
 	760+1005+000	4009729029473



flat screen supports – Novus Tetra-Support-System





2
Years
Guarantee



NOVUS FileMaster 34

- Shelf for mounting on top of extensible more space system products
- High quality, ribbed aluminium surface with back edge
- Ideal for opposite arranged working surfaces
- Rotating around 360°
- Shelf depth: 304 mm
- Width: 340 mm
- Can also be hooked into SlatWall elements

Colours	Art.No.	EAN Code
	762+0345+000	4009729029442
	762+0342+000	4009729029435

Novus LiftTEC®: everything perfectly in control

The NOVUS LiftTEC® series enables monitors weighing 3-15 kg to be conveniently and safely secured. Height adjustments are child's play. The gas pressure technology and the ball-and-socket joint make it particularly easy to perform ergonomic positioning of the monitor. The monitor can therefore be moved quickly to various different positions ideal for individual users.

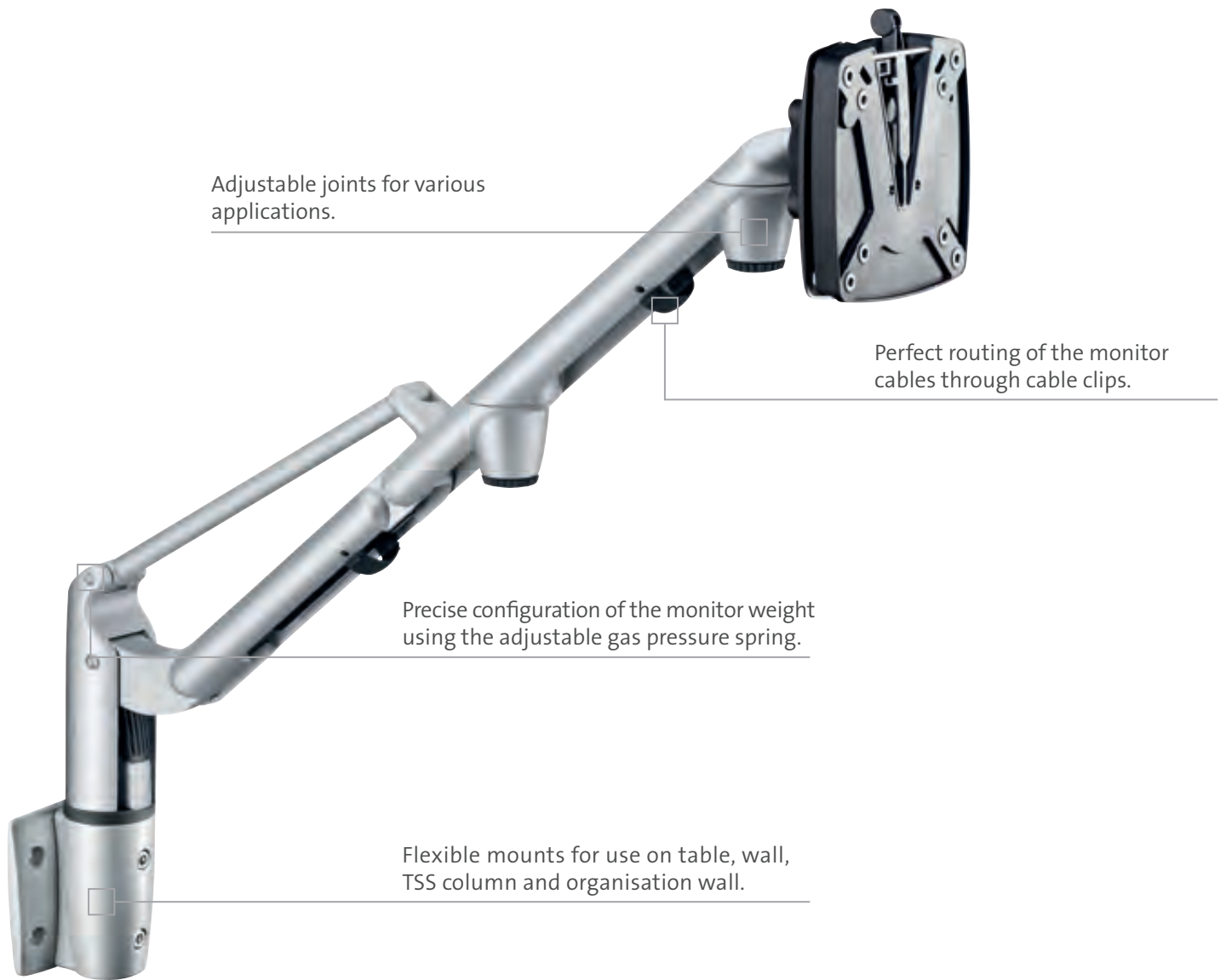

Mounts for every workstation

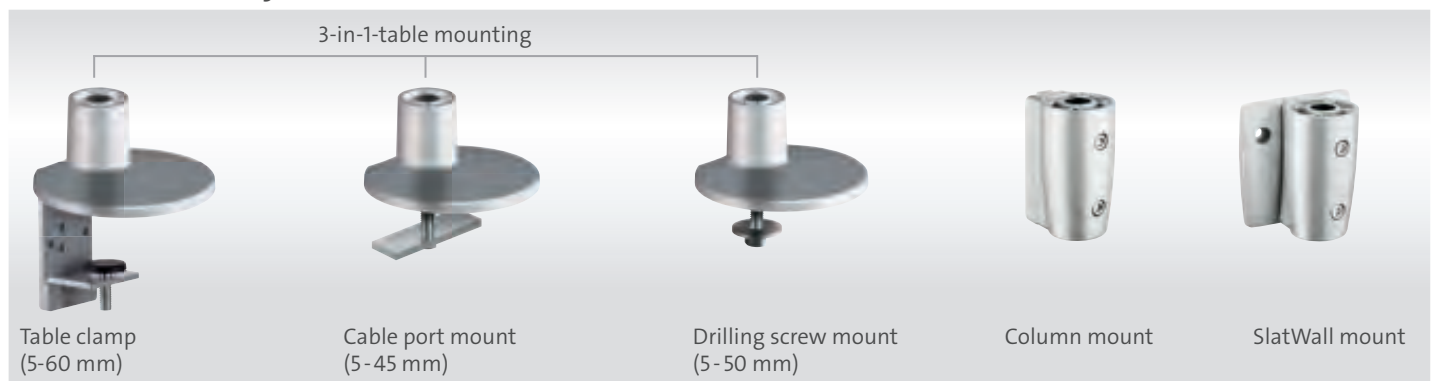

Flat-screen monitor holder – Novus LiftTEC®



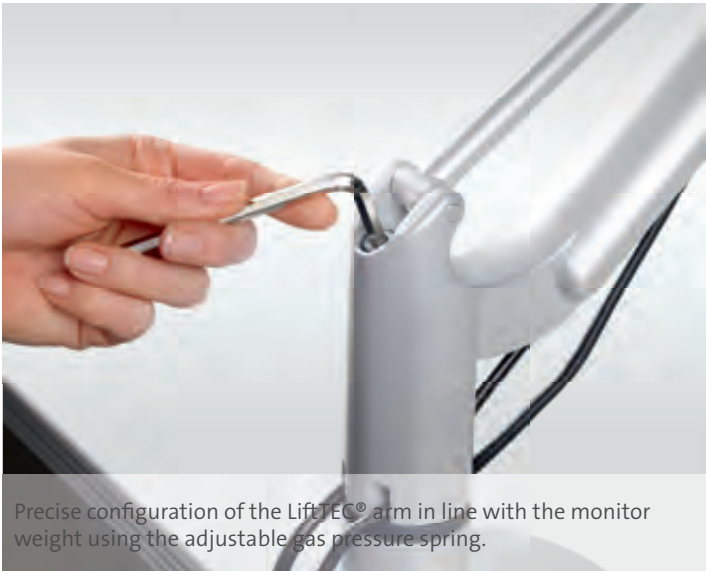

Sophisticated functions for an ergonomic workstation





NOVUS LiftTEC Arm I, with table mount





- 1-part monitor supporting arm with gas spring technology for comfortable, ergonomic adjustment
- 3 in 1 mounting (clamp, cable port or drilling screw)
- Easy mounting of the monitor by quick release with one hand operation, suitable for attachment standard 75/100
- Mounting of flat screens of 3-8 kg or 7-15 kg
- Range: 365 mm
- Perfect cable management by cable clips

Colours	Art.No.	EAN Code
 	930+1089+000	4009729044551
 	930+1159+000	4009729044568



NOVUS LiftTEC Arm II, with table mount

- 2-part monitor supporting arm with gas spring technology for comfortable, ergonomic adjustment
- 3 in 1 mounting (clamp, cable port or drilling screw)
- Easy mounting of the monitor by quick release, suitable for mounting standard 75/100
- Mounting of flat screens of 3-8 kg or 7-15 kg
- Range: 515 mm
- Perfect cable management by cable clips

Colours	Art.No.	EAN Code
 	930+2089+000	4009729043868
 	930+2159+000	4009729043875





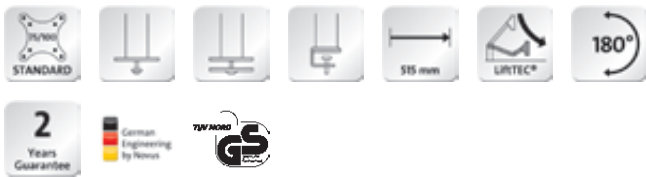

flat screen supports – Novus LiftTEC®



NOVUS LiftTEC Arm III, with table mount





- 2-part monitor supporting arm with gas spring technology for comfortable, ergonomic adjustment
- With straight front arm section for a very low screen positioning
- 3 in 1 mounting (clamp, cable port or drilling screw)
- Easy mounting of the monitor by quick release, suitable for mounting standard 75/100
- Mounting of flat screens of 3-8 kg or 7-15 kg
- Range: 515 mm
- Perfect cable management by cable clips

Colours	Art.No.	EAN Code
 	930+3089+000	4009729045398
 	930+3159+000	4009729045404



NOVUS TSS-LiftTEC-Arm I, with column mount

- 1-part monitor supporting arm with gas spring technology for comfortable, ergonomic adjustment
- With TSS column adapter
- Easy mounting of the monitor by quick release, suitable for mounting standard 75/100
- Mounting of flat screens of 3-8 kg or 7-15 kg
- Range: 397 mm
- Perfect cable management by cable clips
- Obligatory supplement is a TSS column





Colours	Art.No.	EAN Code
 	980+1089+000	4009729044612
 	980+1159+000	4009729044629





NOVUS TSS-LiftTEC-Arm II, with column mount





- 2-part monitor supporting arm with gas spring technology for comfortable, ergonomic adjustment
- With TSS column adapter
- Easy mounting of the monitor by quick release, suitable for mounting standard 75/100
- Mounting of flat screens of 3-8 kg or 7-15 kg
- Range: 547 mm
- Perfect cable management by cable clips
- Obligatory supplement is a TSS column

Colours	Art.No.	EAN Code
 	980+2089+000	4009729043882
 	980+2159+000	4009729043899



NOVUS TSS-LiftTEC-Arm III, with column mount

- 2-part monitor supporting arm with gas spring technology for comfortable, ergonomic adjustment
- With straight front arm section for a very low screen positioning
- With TSS column adapter
- Easy mounting of the monitor by quick release, suitable for mounting standard 75/100
- Mounting of flat screens of 3-8 kg or 7-15 kg
- Range: 547 mm
- Perfect cable management by cable clips
- Obligatory supplement is a TSS column

Colours	Art.No.	EAN Code
 	980+3089+000	4009729045435
 	980+3159+000	4009729045442



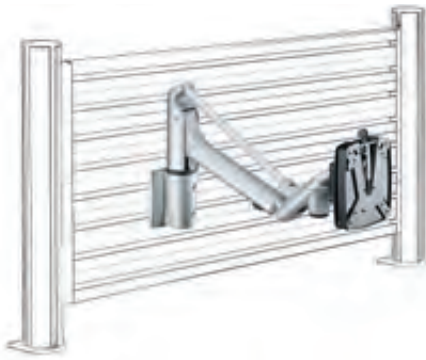

flat screen supports – Novus LiftTEC®



NOVUS SlatWall LiftTEC Arm I, with SlatWall mount

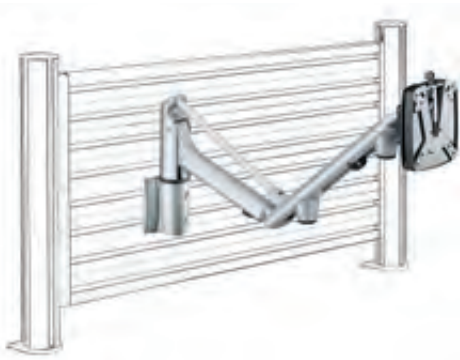

- 1-part monitor supporting arm with gas spring technology for comfortable, ergonomic adjustment
- With SlatWall adapter
- Easy mounting of the monitor by quick release, suitable for mounting standard 75/100
- Mounting of flat screens of 3-8 kg
- Range: 400 mm
- Perfect cable management by cable clips
- Obligatory supplement is a SlatWall element

Colours	Art.No.	EAN Code
 	981+1089+000	4009729044643



NOVUS SlatWall LiftTEC Arm II, with SlatWall mount

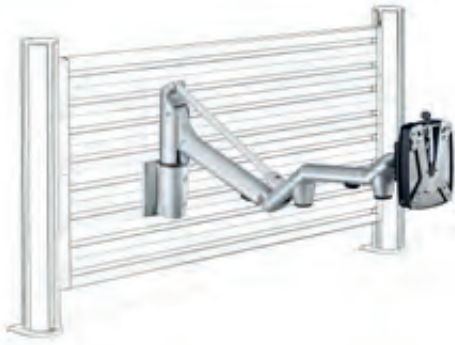

- 2-part monitor supporting arm with gas spring technology for comfortable, ergonomic adjustment
- With SlatWall adapter
- Easy mounting of the monitor by quick release, suitable for mounting standard 75/100
- Mounting of flat screens of 3-8 kg
- Range: 550 mm
- Perfect cable management by cable clips
- Obligatory supplement is a SlatWall element

Colours	Art.No.	EAN Code
 	981+2089+000	4009729044636



NOVUS SlatWall LiftTEC Arm III, with SlatWall mount



- 2-part monitor supporting arm with gas spring technology for comfortable, ergonomic adjustment
- With straight front arm section for a very low screen positioning
- With SlatWall adapter
- Easy mounting of the monitor by quick release, suitable for mounting standard 75/100
- Mounting of flat screens of 3-8 kg
- Range: 550 mm
- Perfect cable management by cable clips
- Obligatory supplement is a SlatWall element

Colours	Art.No.	EAN Code
 	981+3089+000	4009729045459



NOVUS LiftTEC Arm I, with wall mount

- 1-part monitor supporting arm with gas spring technology for comfortable, ergonomic adjustment
- With wall bracket
- Easy mounting of the monitor by quick release, suitable for mounting standard 75/100
- Mounting of flat screens of 3-8 kg depending on wall texture
- Range: 400 mm
- Perfect cable management by cable clips

Colours	Art.No.	EAN Code
 	931+1089+000	4009729044599





flat screen supports – Novus LiftTEC®



NOVUS LiftTEC Arm II, with wall mount



- 2-part monitor supporting arm with gas spring technology for comfortable, ergonomic adjustment of the monitor for mounting directly on the wall
- With wall bracket
- Easy mounting of the monitor by quick release, suitable for mounting standard 75/100
- Mounting of flat screens of 3-8 kg depending on wall texture
- Range: 550 mm
- Perfect cable management by cable clips

Colours	Art.No.	EAN Code
 	931+2089+000	4009729044575



NOVUS LiftTEC Arm III, with wall mount



- 2-part monitor supporting arm with gas spring technology for comfortable, ergonomic adjustment of the monitor for mounting directly on the wall
- With straight front arm section for a very low screen positioning
- With wall bracket
- Easy mounting of the monitor by quick release, suitable for mounting standard 75/100
- Mounting of flat screens of 3-8 kg depending on wall texture
- Range: 550 mm
- Perfect cable management by cable clips

Colours	Art.No.	EAN Code
 	931+3089+000	4009729045411



NOVUS LiftTEC Arm I Dual, with table mount



- Double monitor support arm for comfortable, ergonomic adjustment of the monitor to the personal needs with gas spring
- 3 in 1 mounting (clamp, cable port or drilling screw)
- Easy mounting of the monitor by quick release, suitable for mounting standard 75/100
- Mounting of two flat screens up to 7 kg alongside or above one another
- Range: 415 mm
- Perfect cable management by cable clips

Colours	Art.No.	EAN Code
 	930+1279+000	4009729046456



NOVUS TSS-LiftTEC-Arm I Dual, with column mount

- Double monitor support arm for comfortable, ergonomic adjustment of the monitor to the personal needs with gas spring
- Easy mounting of the monitor by quick release, suitable for mounting standard 75/100
- Mounting of two flat screens up to 7 kg alongside or above one another
- Range: 447 mm
- Perfect cable management by cable clips
- Obligatory supplement is a TSS column

Colours	Art.No.	EAN Code
 	980+1279+000	4009729046463





flat screen supports – Novus LiftTEC®



NOVUS TSS-LM-Arm 0-0-1, with column mount



- High quality infinitely height adjustable support carriage
- With TSS column adapter
- Easy mounting of the monitor by quick release, suitable for mounting standard 75/100
- Mounting of flat screens up to 15 kg
- Range: 122 mm
- Obligatory supplement is a TSS column

Colours	Art.No.	EAN Code
 	980+0159+000	4009729045756



NOVUS TSS-LM-Arm 0-2-1, with column mount



- High quality infinitely height adjustable 2-part monitor support arm
- With TSS column adapter
- Easy mounting of the monitor by quick release, suitable for mounting standard 75/100
- Mounting of flat screens up to 15 kg
- Ergonomic monitor setting to the personal needs by various joints
- Range: 272 mm
- Perfect cable management by cable clips
- Obligatory supplement is a TSS column

Colours	Art.No.	EAN Code
 	980+4159+000	4009729045763



NOVUS TSS-LM-Arm 0-0-4 Dual, with column mount



- High quality infinitely height adjustable double monitor support arm
- With TSS column adapter
- Easy mounting of the monitor by quick release, suitable for mounting standard 75/100
- Mounting of two flat screens up to 7 kg alongside or above one another
- Range: 172 mm
- Perfect cable management by cable clips
- Obligatory supplement is a TSS column

Colours	Art.No.	EAN Code
 	980+0279+000	4009729046517



NOVUS SlatWall LM-Arm 0-0-1, with SlatWall mount



- High quality support carriage
- With SlatWall adapter
- Easy mounting of the monitor by quick release, suitable for mounting standard 75/100
- Mounting of flat screens up to 8 kg
- High mobility in confined space by ball joint
- Range: 125 mm
- Obligatory supplement is a SlatWall element

Colours	Art.No.	EAN Code
 	981+0089+000	4009729045824



NOVUS SlatWall LM-Arm 0-2-1, with SlatWall mount

- High quality monitor support arm
- With straight front arm section for a very low screen positioning
- With SlatWall adapter
- Easy mounting of the monitor by quick release, suitable for mounting standard 75/100
- Mounting of flat screens up to 8 kg
- Various joints for high mobility
- Range: 275 mm
- Perfect cable management by cable clips
- Obligatory supplement is a SlatWall element

Colours	Art.No.	EAN Code
 	981+4089+000	4009729045831

flat screen supports – Novus LiftTEC®



2
Years
Guarantee



NOVUS Balance 30

- Height adjustment to compensate different heights of parallel arranged monitors
- Compensation range: + - 30 mm
- For monitors suitable for mounting standard 75/100
- Necessary when using the SlatWall LM arm 0-0-1 and SlatWall LM arm 0-2-1 in combination next to each other

Colours	Art.No.	EAN Code
	795+9075+000	4009729047170



NOVUS LM arm 0-0-1 WH

- High quality support carriage for mounting a monitor directly to the wall
- With wall bracket
- Easy mounting of the monitor by quick release, suitable for mounting standard 75/100
- Mounting of flat screens up to 8 kg depending on wall texture
- High mobility in confined space by ball joint
- Wall distance: 125 mm

Colours	Art.No.	EAN Code
	931+0089+000	4009729045688



NOVUS LM-Arm 0-2-1, with wall mount

- High quality monitor support for attaching a monitor directly to the wall
- With wall bracket
- Easy mounting of the monitor by quick release, suitable for mounting standard 75/100
- Mounting of flat screens up to 8 kg depending on wall texture
- Various joints for high mobility
- Range: 275 mm
- Perfect cable management by cable clips

Colours	Art.No.	EAN Code
	931+4089+000	4009729045695



Novus Screen Mount: high performance creates a big impression

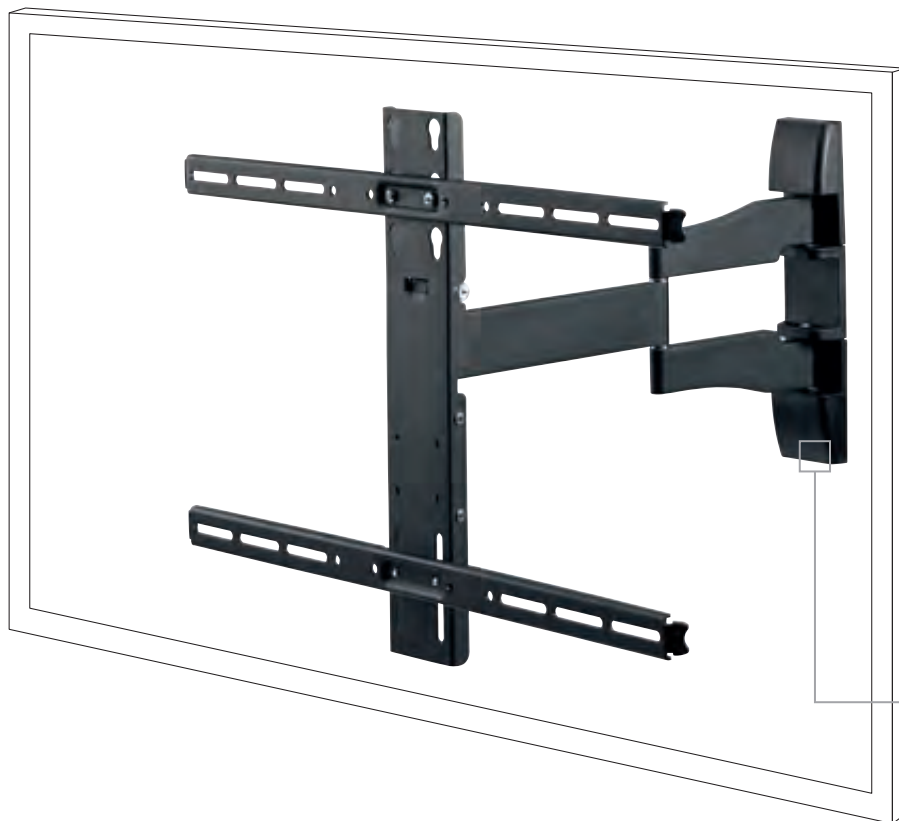

The Novus ScreenMount series is specially designed for the attachment of monitors that are heavy (30-100 kg) and particularly of those that are large (up to 70 inch).



Easy, secure and convenient mounting on the wall – thanks to the integrated spirit level.

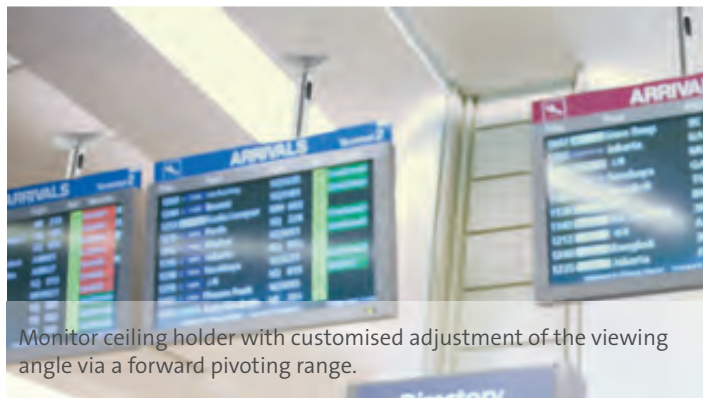

Monitor ceiling holder with customised adjustment of the viewing angle via a forward pivoting range.

Three options for monitor mounting



Flat-screen monitor holder – Novus ScreenMount



NOVUS ScreenMount Fix 400, wall mount

- Sturdy wall mount for mounting large screens particularly close to the wall
- Suitable for mounting standards: 100x100, 200x100, 200x200, 300x300, 400x200, 400x300
- Mounting of flat screens up to 35 kg
- Wall distance: 35 mm
- In high-quality metal with powder-coated finish
- Reliable drop guard as protection against unintentional release of screen
- Integrated spirit level for ease of installation

Colours	Art.No.	EAN Code
	940+0405+000	4009729055465



NOVUS ScreenMount Fix 700, wall mount

- Sturdy wall mount for mounting very large flat screens particularly close to the wall
- Suitable for mounting standards: 100x100, 200x100, 200x200, 300x300, 400x200, 400x400, 600x200, 600x400
- Mounting of flat screens up to 45 kg
- Wall distance: 35 mm
- In high-quality metal with powder-coated finish
- Reliable drop guard as protection against unintentional release of screen
- Integrated spirit level for ease of installation

Colours	Art.No.	EAN Code
	940+0705+000	4009729055472





NOVUS ScreenMount Vario 400, wall mount

- Tilting wall mount for mounting large screens close to the wall
- Suitable for mounting standards: 100x100, 200x100, 200x200, 300x300, 400x200, 400x400
- Mounting of flat screens up to 35 kg
- Wall distance: 61 mm
- Five adjustable tilt angles of 0°, 4°, 8°, 12° or 16° for any chosen viewing angle
- In high-quality metal with powder-coated finish
- Reliable drop guard as protection against unintentional release of screen
- Integrated spirit level for ease of installation



Colours	Art.No.	EAN Code
	943+0405+000	4009729055489



NOVUS ScreenMount Vario 700, wall mount

- Tilting wall mount for mounting large screens close to the wall
- Suitable for mounting standards: 100x100, 200x100, 200x200, 300x300, 400x200, 400x400, 600x200, 600x400
- Mounting of flat screens up to 45 kg
- Wall distance: 61 mm
- Five adjustable tilt angles of 0°, 4°, 8°, 12° or 16° for any chosen viewing angle
- In high-quality metal with powder-coated finish
- Reliable drop guard as protection against unintentional release of screen
- Integrated spirit level for ease of installation



Colours	Art.No.	EAN Code
	943+0705+000	4009729055496



NOVUS ScreenMount Flex, wall mount

- High-quality wall mount with flexible articulated arm for holding particularly large screens
- Suitable for mounting standards: 200x200, 300x300, 400x200, 400x400, 600x200, 600x400
- For mounting flat screens weighing up to 30 kg
- three joints provide positioning flexibility
- Wall distance: from a minimum of 39 mm to a maximum of 490 mm
- 180° swivelling range and forward tilt angle of up to 20° for any chosen viewing angle
- In high-quality metal with powder-coated finish
- Complete with spirit level for ease of installation



Colours	Art.No.	EAN Code
	943+4905+000	4009729055502

Flat-screen monitor holder – Novus ScreenMount



NOVUS ScreenMount Ceiling 140, ceiling mount

- Sturdy ceiling mount with telescopic extension for holding particularly large screens
- The distance from the ceiling can be varied between 77 cm and 144 cm, providing flexible adjustability to ceiling height
- Suitable for mounting standards: 200x100, 200x200, 300x300, 400x200, 400x400, 600x200, 600x400, 800x200, 800x400
- Mounting of flat screens up to 100 kg
- 360° turning function and forward tilt angle of up to 15° for any chosen angle viewing angle
- Internal cable routing for optimum cable management
- In high-quality aluminium and metal
- Reliable drop guard as protection against unintentional release of screen

Colours	Art.No.	EAN Code
	944+1409+000	4009729055519



NOVUS ScreenMount Ceiling 220, ceiling mount

- Sturdy ceiling mount with telescopic extension for holding particularly large screens
- The distance from the ceiling can be varied between 118 cm and 220 cm, providing flexible adjustability to ceiling height
- Suitable for mounting standards: 200x100, 200x200, 300x300, 400x200, 400x400, 600x200, 600x400, 800x200, 800x400
- Mounting of flat screens up to 100 kg
- 360° turning function and forward tilt angle of up to 15° for any chosen angle viewing angle
- Internal cable routing for optimum cable management
- In high-quality metal with powder-coated finish
- Reliable drop guard as protection against unintentional release of screen

Colours	Art.No.	EAN Code
	944+2209+000	4009729055526



NOVUS ScreenMount Stand, support stand

- Universal support stand for mounting particularly large screens
- Suitable for the following mounting standards: 200x100, 200x200, 300x300, 400x200, 400x400, 600x200, 600x400
- For mounting flat screens weighing up to 30 kg
- 60° swivelling range for any chosen viewing angle
- Cable holder behind the column for perfect cable management
- Support stand in high-quality aluminium with baseplate finished in high-gloss lacquer
- Reliable drop guard as protection against unintentional release of screen

Colours	Art.No.	EAN Code
	945+1749+000	4009729055533



NOVUS QuickMount

- For the particularly flat mounting of monitors on the wall
- Easy mounting of the monitor by quick release with one hand operation, suitable for attachment standard 75/100
- For mounting flat screens weighing up to 25 kg
- Wall distance: 20 mm

Colours	Art.No.	EAN Code
	931+0255+000	4009729046043



NOVUS ScreenMaster Frame

- Slim-line wall mount with locking catch for large screens
- Quick fastening system for easy screen attachment
- Mounting of flat screens up to 20 kg (200x200, 300x300) or up to 30kg (400x400, 600x400)
- Distance from wall: from just 30 mm to 50 mm (in 5 stages)
- In high-quality metal with powder-coated finish

Colours	Art.No.	EAN Code
	940+2205+000	4009729058152
	940+3305+000	4009729061640
	940+4405+000	4009729058176
	940+6405+000	4009729058190

Flat-screen monitor holder – Novus ScreenMount



NOVUS ScreenMaster 100

- Very slim wall mount for flat screens
- Quick fastening system for easy screen attachment
- Flat distance to the wall of about 20 mm
- For mounting flat screens weighing up to 25 kg
- In high-quality metal with powder-coated finish

Colours	Art.No.	EAN Code
	940+1009+000	4009729061749



NOVUS SKY WallMount

- Wall bracket for attachment to the wall, depending on the wall texture
- Easy mounting of the monitor by quick release with one hand operation, suitable for mounting standard 75/100
- Mounting of flat screens up to 10 kg
- Swivelling and tiltable
- Wall distance: 125 mm



Colours	Art.No.	EAN Code
	950+0019+100	4009729053348





NOVUS TabletSafe Android

- Mobile tablet holder as the practical and modern basis for presentation and communication
- Universal tablet frame for 9-10-inch Android tablets
- High-quality metal frame with velour chrome surface and lacquered display bezel
- In the anthracite-coloured version, metal frame and display bezel are finished in matching lacquer
- Metal clips in the enclosure permit exact positioning of different tablets in the frame.
- Cleverly designed cable routing allows the tablet to be used all the time with the charging cable connected
- Dimensions: W 301.5 x H 231.5 x D 20 mm
- Can be combined with TabletSafe stands and wall mounts as well as with all connect columns and connect support arms

Colours	Art.No.	EAN Code
	881+0318+000	4009729057124
	881+0308+000	4009729057131
	881+0301+000	4009729057148



tablet holder – Novus TabletSafe





2
Years
Guarantee



NOVUS TabletSafe iPad

- Mobile tablet holder as the practical and modern basis for presentation and communication
- Universal tablet frame for 9-10-inch Apple iPads
- High-quality metal frame with velour chrome surface and lacquered display bezel
- In the anthracite-coloured version, metal frame and display bezel are finished in matching lacquer
- Metal clips in the enclosure permit exact positioning of different tablets in the frame.
- Cleverly designed cable routing allows the tablet to be used all the time with the charging cable connected
- Dimensions: W 301.5 x H 231.5 x D 20 mm
- Can be combined with TabletSafe stands and wall mounts as well as with all connect columns and connect support arms



Colours	Art.No.	EAN Code
	881+1318+000	4009729057155
	881+1308+000	4009729057162
	881+1301+000	4009729057179







NOVUS DeskStand

- Desktop stand for NOVUS TabletSafe
- Mobile tablet holder as the practical and modern basis for presentation and communication
- Stylish metal base provides firm standing
- Ideal for using the TabletSafe on the desk, table or counter
- The connect joint provides a swivelling range of 360 degrees - with concealed cable routing, the tablet can be turned through +/- 45 degrees
- Height of the column: 200 mm

Colours	Art.No.	EAN Code
	882+0205+000	4009729061053
	882+0209+000	4009729057186

NOVUS FloorStand

- Floor stand for NOVUS TabletSafe
- Mobile tablet holder as the practical and modern basis for presentation and communication
- Stylish metal base provides firm standing
- Ideal for using the TabletSafe in the showroom or shop window
- The connect joint provides a swivelling range of 360 degrees - with concealed cable routing, the tablet can be turned through +/- 45 degrees
- Height of the column: 1000 mm

Colours	Art.No.	EAN Code
	882+1005+000	4009729061060
	882+1009+000	4009729057193

2
Years
Guarantee



2
Years
Guarantee

German
Engineering
by Novus

tablet holder – Novus TabletSafe



NOVUS DeskMount

- Simple desktop stand for NOVUS TabletSafe
- Ideal for using the TabletSafe on the desk, table or counter
- With fixed angle of inclination of 55 degrees
- In high-quality metal with powder-coated finish

Colours	Art.No.	EAN Code
	882+0025+000	4009729057209

2
Years
Guarantee



NOVUS WallMount

- Wall mount for attachment of the TabletSafe to the wall
- With fixed tilting angle of 33 degrees

Colours	Art.No.	EAN Code
	882+0035+000	4009729057216



NOVUS adapter plate 200 x 100

- Adapter plate for connection medium size monitors to the mounting standard 75/100
- Suitable for the following mounting standards: 200x100

Colours	Art.No.	EAN Code
	795+9055+000	4009729044513



NOVUS adapter plate 200 x 200

- Adapter plate for connection of large monitors to the mounting standard 75/100
- Suitable for the following mounting standards: 200x100, 200x200

Colours	Art.No.	EAN Code
	795+9065+000	4009729046814



NOVUS standard mounting adapter set

- Adapter plate set for connecting large monitors to attachment standard 200/100 or 200/200
- Suitable for the following mounting standards: 400x400, 300x300
- To be used with Novus TSS support carriage 32 and supporting arm 32

Colours	Art.No.	EAN Code
	795+9105+000	4009729059333



flat screen supports – Accessory



NOVUS spacer set

- Accessories for monitors with embedded mounting standards 75/100
- To be used if NOVUS standard attachments screws are not applicable to the monitor model
- Comprising: four spacer and four longer screws

Colours	Art.No.	EAN Code
	796+0905+000	4009729047606



NOVUS Cable Guide

- Textile material cable conduit for flexible cable organisation
- Up to a diameter of 4 cm, the cable conduit enables a perfect guidance and organisation of the cables
- Available in length: 180 cm

Colours	Art.No.	EAN Code
	795+1808+000	4009729051696



NOVUS dummy monitor

- Dummy monitor for use in showrooms or at trade fairs
- Illustrates how flat screen holders work
- Mounting standard 100x100
- Dimensions: W 430 mm, H 310 mm, D 20 mm
- Transparent acrylic glass with printed NOVUS logo
- Weight: 3,2 kg

Colours	Art.No.	EAN Code
	795+9000+000	4009729058787





Optimum lighting at every workstation – flexible articulated arms ensure dimmable light is always available where it is needed.

The right light
in the right place.



Novus lights: The Novus lighting assortment enables an optimal workspace illumination. This way a perfect work environment can be created.



Attenzia mounting options

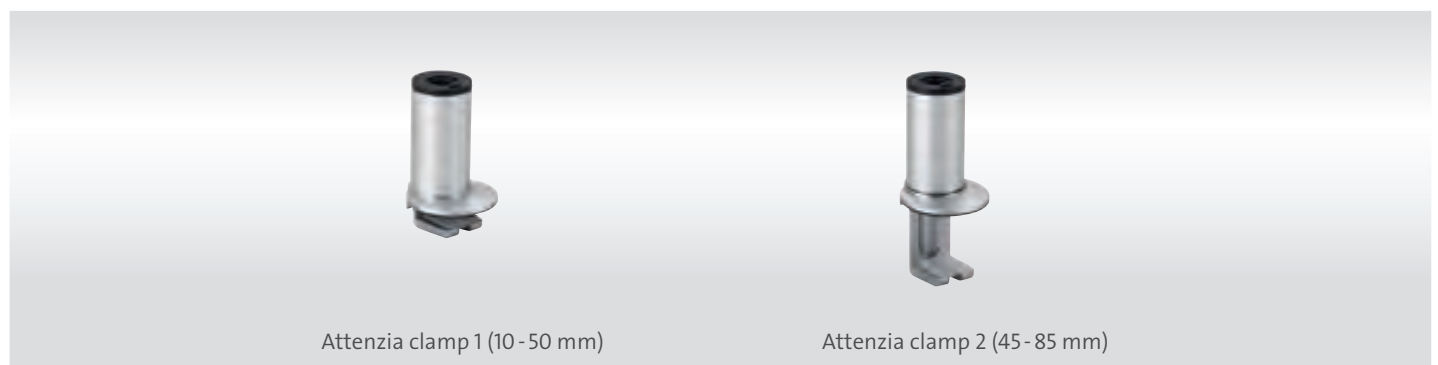

Perfect lighting conditions for every situation



NOVUS Attenzia:
Infinitely dimmable with automatic switch off.



NOVUS Attenzia:
High quality joints enable flexibility



NOVUS Office Light Luma:
Modern LED desk light with 2-part aluminium arm.



NOVUS Office Light Luma:
Adjustable joint for infinitely height positioning.



NOVUS Office Light Corona:
Intelligent circuitry provides infinitely dimming.



NOVUS Office Light Corona:
Combinable with product of the more space system.



NOVUS Attenzia complete, for fitting onto a column

- Smart designed LED light with slim-line aluminium support arm and internal cable routing for illuminating the entire work space
- High quality aluminium finish with anodised and galvanised surfaces
- The light can be dimmed to any level and switches off automatically.
- Luminaire luminous flux of 1708 lm for perfect illumination
- Extremely energy efficient at luminaire light efficiency with 83,3 lm/W
- Good colour recognition thanks to high colour rendering index of 86 (>80)
- Stimulating neutral white light colour with a colour temperature of 4000 K
- Large operating range: 726mm
- Cable length: approx. 2 m
- For fitting onto a NOVUS MY column, supplied without mount
- This luminaire contains built-in LED lamps
- This luminaire is compatible with bulbs of the energy classes A, A+, A++
- The lamps cannot be changed in the luminaire
- ENEC safety sign
- Average illuminance: E=1714 Lux

Colours	Art.No.	EAN Code
	740+2109+000	4009729061961

NOVUS MY base

- The obligatory column to mount the Attenzia complete



Säulen	Art.-Nr.	EAN-Nr.
MY base C MY column 350mm, clamp 14-40 mm	911+0019+000	4009729 052 907
MY base C1 MY column 350mm, clamp 13-25mm	911+0029+000	4009729 053 867
MY base D MY column 350 mm, Drilling screw fitting	911+0049+000	4009729 052 914
MY base G MY column 350 mm, Cable port mount	911+0059+000	4009729 052 921
MY base S MY column 350 mm, System rail attachment	911+0069+000	4009729 052 938







NOVUS Attenzia task, with clamp 1

- Smart designed LED desk light with slim-line 2-part aluminium support arm and internal cable routing
- High quality aluminium finish with anodised and galvanised surfaces
- The light can be dimmed to any level and switches off automatically.
- Luminaire luminous flux of 742 lm for perfect illumination
- Extremely energy efficient at luminaire light efficiency with 82,7 lm/W
- Good colour recognition thanks to high colour rendering index of 86 (>80)
- Stimulating neutral white light colour with a colour temperature of 4000 K
- Large operating range: 1015 mm
- Cable length: approx. 2 m
- This luminaire contains built-in LED lamps
- This luminaire is compatible with bulbs of the energy classes A, A+, A++
- The lamps cannot be changed in the luminaire
- ENEC safty sign
- Average illuminance: E=1273 Lux

Colours	Art.No.	EAN Code
	740+1211+000	4009729062678
	740+1218+000	4009729062692
	740+1219+000	4009729061732



NOVUS Attenzia task without mount



Colours	Art.No.	EAN Code
	740+1201+000	4009729062661
	740+1208+000	4009729062685
	740+1209+000	4009729061725





NOVUS Attenzia clamp 1

- Clamp for mounting on desktops
- Clamping length: 10-50 mm
- Suitable for NOVUS Attenzia

Colours	Art.No.	EAN Code
	798+0011+000	4009729062708
	798+0018+000	4009729062715
	798+0019+000	4009729061695





2
Years
Guarantee



NOVUS Attenzia clamp 2

- Clamp, especially for mounting on big desktops
- Clamping length: 45-85 mm
- Suitable for NOVUS Attenzia

Colours	Art.No.	EAN Code
	798+0021+000	4009729062722
	798+0028+000	4009729062739
	798+0029+000	4009729061701





2
Years
Guarantee





NOVUS OfficeLight Luma

- Modern LED desk light with desk clamp and 2-part aluminium arm
- High-quality light head in aluminium for optimum heat exchange
- Adjustable joints and spring balancing mechanism for an infinitely variable height adjustment
- Large operating range: 890 mm
- Integrated cable routing, cable length: approx. 2.2 m
- In high-quality aluminium
- The light has an electronic plug-in transformer
- Also available with stand
- This luminaire contains built-in LED lamps
- LED lamps: 7 LEDs, each 1.2 watts
- This luminaire is compatible with bulbs of the energy classes A, A+, A++
- The lamps cannot be changed in the luminaire
- Main voltage required 100 - 240 V, 50 / 60 Hz
- Light measurement data: colour temperature 5000 K, 780 lm, 1250 lux (40 cm height), consumption 8.2 W - in standby mode 0.2 W

Colours	Art.No.	EAN Code
 	739+0009+000	4009729054239

NOVUS OfficeLight Luma support stand

- Stand (6 kg)
- Stable, elegant base for the desk
- Diameter: 260 mm
- In high-quality metal with powder-coated finish





Colours	Art.No.	EAN Code
	795+7819+000	4009729054321





NOVUS OfficeLight Corona II



- Modern LED Desk Light with 6 powerful LEDs and 2-piece aluminium arm
- Intelligent circuitry provides the NOVUS OfficeLight Corona with infinitely variable dimming
- Adjustable joints and spring balancing mechanism for an infinitely variable height adjustment
- Large operating range: 995 mm
- Cable length: approx. 2 m
- This luminaire contains built-in LED lamps
- This luminaire is compatible with bulbs of the energy classes A, A+, A++
- The lamps cannot be changed in the luminaire

Colours	Art.No.	EAN Code
 LED 8,5 W	737+0002+000	4009729047804
 LED 8,5 W	737+0009+000	4009729047811



NOVUS OfficeLight PRO II



- High quality desk light with 2-piece aluminium support arm
- Anti-glare working by the mirror-finish parabolic grid reflector
- Adjustable joints and spring balancing mechanism for an infinitely variable height adjustment
- Large operating range: 980 mm
- Cable length: approx. 2 m
- Supplied with 18 W TC-L compact fluorescent lamp
- This luminaire is compatible with bulbs of the energy classes A, B, C, D und E
- This luminaire is sold with a bulb of the energy class A.

Colours	Art.No.	EAN Code
 TC-L 18 W	735+0012+000	4009729041475
 TC-L 18 W	735+0019+000	4009729041499



NOVUS OfficeLight deLuxe II

- Flexible desk light with 2-piece aluminium support arm
- Adjustable joints and spring balancing mechanism for an infinitely variable height adjustment
- Large operating range: 1075 mm
- Cable length: approx. 2 m
- Supplied with 11 or 18 watt compact fluorescent lamp
- This luminaire is compatible with bulbs of the energy classes A, B, C, D und E
- This luminaire is sold with a bulb of the energy class A.

Colours	Art.No.	EAN Code
 TC-L 18 W	732+0012+000	4009729017388
 TC-L 18 W	732+0019+000	4009729022511



Diverse accessories and storage options help create a tidy and customised workstation for a better overview.

System for greater individuality
and more free space.





NOVUS PhoneMaster

- Compact design offering a high carrying capacity making it particularly suitable for larger and heavier-type telephones
- Table mounting with universal clamp 1 for a table thickness of 18-74 mm
- Swivelling around 360° for ease of movement
- Platform can be mounted crossways or lengthways
- Dimensions base plate: 258 x 172 mm

Colours	Art.No.	EAN Code
	713+0005+000	4009729019405
	713+0002+000	4009729019399



NOVUS ScopeMaster

- Smoothly telescoping swivel arm for positioning of devices in the third level
- Table mounting with universal clamp 1 for a table thickness of 18-74 mm
- Rotating support platform, inclined towards the user
- Swivelling around 360° for ease of movement
- Platform can be mounted crossways or lengthways
- Internal cable routing for optimum cable management
- Dimensions base plate: 258 x 172 mm

Colours	Art.No.	EAN Code
	714+0002+000	4009729019511
	714+0009+000	4009729042465

office organisation – universal support arms

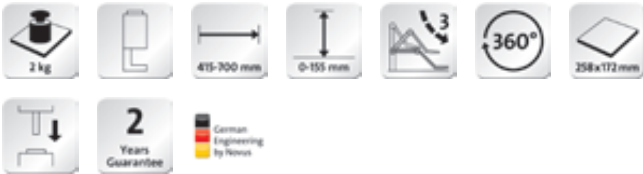

NOVUS TalkMaster

- Telephone swivel arm with 2-part articulated arm for filing the phone in the third level
- Table mounting with universal clamp 1 for a table thickness of 18-74 mm
- 3-stage adjustment for flexible positioning
- Swivelling around 360° for ease of movement
- Platform can be mounted crossways or lengthways
- Dimensions base plate: 258 x 172 mm

Colours	Art.No.	EAN Code
	710+0005+000	4009729019160
	710+0002+000	4009729019153



NOVUS extension platforms

- Set of two extension plates to enlarge the support plate of universal support arms
- Increase the size of supporting platform from 258 x 172 mm to 258 x 258 mm or 258 x 344 mm
- Supplied with four clip connectors for easy assembling



Colours	Art.No.	EAN Code
	795+0905+000	4009729019627
	795+0902+000	4009729019610



NOVUS CopySwinger I

- Single tray for storage
- Plastic tray with practical recessed grip for ergonomic handling
- Table mounting with universal clamp 1 for a table thickness of 18-74 mm
- Swivelling around 360° for ease of movement
- Supplied with transparent label holder
- Expandable with other more space system products with universal clamp 1





Colours	Art.No.	EAN Code
	720+1005+000	4009729035412
	720+1002+000	4009729035429



NOVUS CopySwinger II

- Two trays among each other for a clearly arranged office organisation
- Plastic tray with practical recessed grip for ergonomic handling
- Table mounting with universal clamp 1 for a table thickness of 18-74 mm
- Swivelling around 360° for ease of movement
- Supplied with transparent label holder
- Expandable with other more space system products with universal clamp 1





Colours	Art.No.	EAN Code
	720+2005+000	4009729018545
	720+2002+000	4009729018538

office organisation – tray sets



NOVUS CopySwinger III



- Three trays among each other for the classic storage
- Plastic tray with practical recessed grip for ergonomic handling
- Table mounting with universal clamp 1 for a table thickness of 18-74 mm
- Swivelling around 360° for ease of movement
- Supplied with transparent label holder
- Expandable with other more space system products with universal clamp 1

Colours	Art.No.	EAN Code
	720+3005+000	4009729018583
	720+3002+000	4009729018576



NOVUS CopySwinger IV



- Four trays among each other offer lots of space
- Plastic tray with practical recessed grip for ergonomic handling
- Table mounting with universal clamp 1 for a table thickness of 18-74 mm
- Swivelling around 360° for ease of movement
- Supplied with transparent label holder
- Expandable with other more space system products with universal clamp 1

Colours	Art.No.	EAN Code
	720+4005+000	4009729018620
	720+4002+000	4009729018613



NOVUS CopySwinger V



- Five trays among each other offer much storage space
- Plastic trays with practical recessed grip for ergonomic handling
- Table mounting with universal clamp 1 for a table thickness of 18-74 mm
- Swivelling around 360° for ease of movement
- Supplied with transparent label holder

Colours	Art.No.	EAN Code
	720+5005+000	4009729018644
	720+5002+000	4009729018637



NOVUS CopySwinger Duo II

- Two sets of two trays about each other
- Plastic tray with practical recessed grip for ergonomic handling
- Table mounting with universal clamp 1 for a table thickness of 18-74 mm
- Swivelling around 360° for ease of movement
- Expandable with other more space system products with universal clamp 1

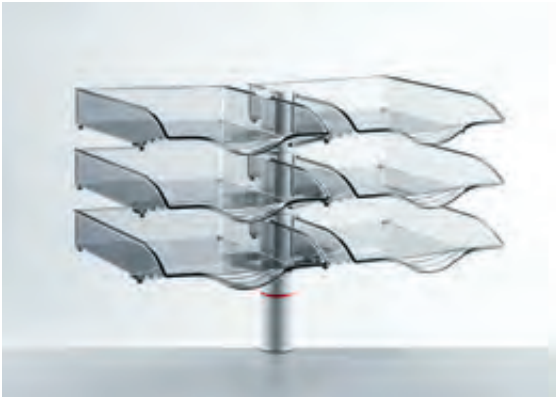

Colours	Art.No.	EAN Code
	721+4005+000	4009729018675
	721+4002+000	4009729018668

office organisation – tray sets



NOVUS CopySwinger Duo III

- Three sets of two trays about each other
- Plastic tray with practical recessed grip for ergonomic handling
- Table mounting with universal clamp 1 for a table thickness of 18-74 mm
- Swivelling around 360° for ease of movement
- Supplied with transparent label holder
- Expandable with other more space system products with universal clamp 1

Colours	Art.No.	EAN Code
	721+6005+000	4009729018712
	721+6002+000	4009729018705

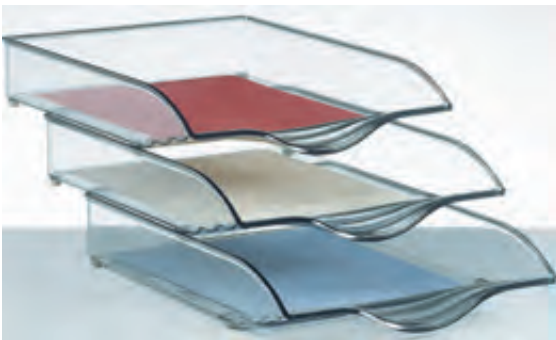

NOVUS CopyTray, single tray

- Stackable and removable B4-single tray
- Plastic tray with practical recessed grip for ergonomic handling
- Supplied with transparent label holder









Colours	Art.No.	EAN Code
	720+0000+000	4009729018651





NOVUS BoardMaster base with supporting feet









- Practical shelves for perfect organisation of the workplace with desktop feet
- Variable division in three compartments
- Elegant desktop feet for placement on the desk
- Shelf depth: 195mm
- Available in length: 1000mm & 1200mm
- Expandable with other more space system products with universal clamp 1

Colours	Art.No.	EAN Code
 	750+0555+000	4009729018774
 	750+0552+000	4009729018767
 	750+0655+000	4009729018811
 	750+0652+000	4009729018804



NOVUS BoardMaster with universal clamp 1

- Practical shelves for perfect organisation of the workplace for mounting at the desktop
- Variable division in three compartments
- Table mounting with universal clamp 1 for a table thickness of 18-74 mm
- Shelf depth: 195mm
- Available in length: 1000mm & 1200mm
- Expandable with other more space system products with universal clamp 1





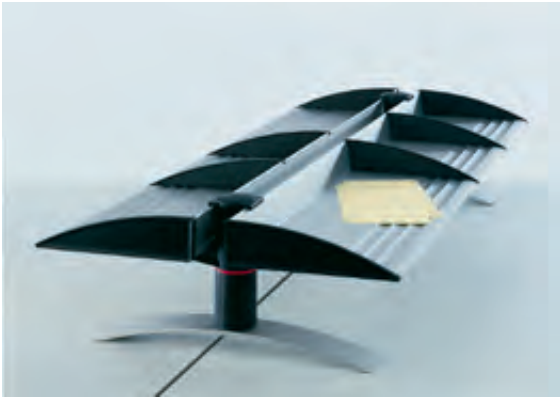



Colours	Art.No.	EAN Code
 	750+0505+000	4009729018750
 	750+0502+000	4009729018743
 	750+0605+000	4009729018798
 	750+0602+000	4009729018781

office organisation – trays and shelves



NOVUS Duo-BoardMaster with supporting feet









- Two opposite boards with desktop feet
- Ideal for opposite arranged working surfaces
- Variable division in three compartments per board
- Elegant desktop feet for placement on the desk
- Shelf depth: 195mm
- Available in length: 1000mm & 1200mm
- Expandable with other more space system products with universal clamp 1

Colours	Art.No.	EAN Code
 	751+2565+000	4009729018934
 	751+2562+000	4009729018927
 	751+2665+000	4009729018972
 	751+2662+000	4009729018965



NOVUS Duo-BoardMaster with universal clamp 1



- Two opposite boards for direct mounting on the desk
- Ideal for opposite arranged working surfaces
- Variable division in three compartments per board
- Table mounting with universal clamp 1 for a table thickness of 18-74 mm
- Shelf depth: 195mm
- Available in length: 1000mm & 1200mm
- Expandable with other more space system products with universal clamp 1

Colours	Art.No.	EAN Code
 	751+2505+000	4009729018910
 	751+2502+000	4009729018903
 	751+2605+000	4009729018958
 	751+2602+000	4009729018941



NOVUS ViewMaster-Fix



- Display pocket holders with 2-piece plastic joints in three automatic locking positions
- For 12 DIN A4 display pockets
- Table mounting with universal clamp 1 for a table thickness of 18-74 mm
- Range: 225 - 514 mm
- Rotating around 360°
- Display pockets can be fitted with indicator tabs to make information easier to find
- Display pockets are not included

Colours	Art.No.	EAN Code
	748+0005+000	4009729017869
	748+0002+000	4009729017852



NOVUS ViewMaster-Ergo II

- Display pocket holders with 2-part aluminium arm, adjustable plastic joints and spring balancing mechanism
- The infinitely adjustment ensures a comfortable presentation of information
- For 12 DIN A4 display pockets
- Table mounting with universal clamp 1 for a table thickness of 18-74 mm
- Range: 744 mm
- Swivelling around 360°
- Reliable drop guard as protection against unintentional release of screen
- Display pockets are not included
- Display pockets can be fitted with indicator tabs to make information easier to find

Colours	Art.No.	EAN Code
	748+2002+000	4009729017838
	748+2009+000	4009729042441

office organisation – display pocket holders









2
Years
Guarantee

German
Engineering
by NOVUS

NOVUS display pockets

- Display pockets with swivel pins and plastic frame for DIN A4
- Open on one long side
- Delivery: individually packaged

Colours	Art.No.	EAN Code
	795+4811+000	4009729018279
	795+4804+000	4009729018248
	795+4801+000	4009729018224
	795+4808+000	4009729018262
	795+4806+000	4009729018255
	795+4812+000	4009729018286
	795+4802+000	4009729018231



2
Years
Guarantee

German
Engineering
by NOVUS

NOVUS indicator tabs

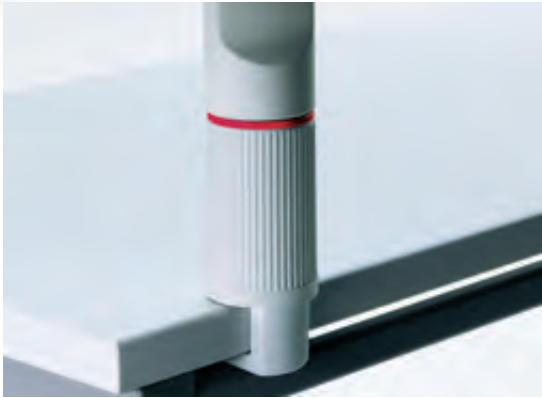

- Indicator tabs set
- Indicator tabs with printed paper inserts from A to Z
- Pluggable with transparent display
- Size: 25x20mm
- Including: 12 pieces

Colours	Art.No.	EAN Code
	795+4850+000	4009729018361



NOVUS universal clamp 1, 18-74mm

- Clamp for mounting on desktops
- Clamping length: 18-74mm
- Suitable for products with universal clamp 1

Colours	Art.No.	EAN Code
	795+0105+000	4009729019665
	795+0102+000	4009729019658



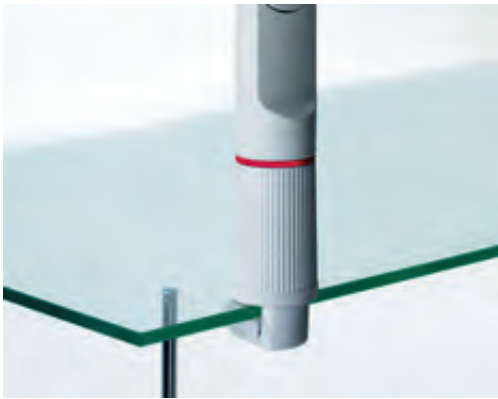

2
Years
Guarantee



NOVUS universal clamp 1, 8-64mm

- Clamp, especially for attachment to glass tables
- Clamping length: 8-64mm
- Suitable for products with universal clamp 1

Colours	Art.No.	EAN Code
	795+0155+000	4009729023402
	795+0152+000	4009729023396





2
Years
Guarantee



NOVUS Plastic screw-on

- Plastic screw-on plate for fixing in the table
- Fixing section: 51 mm
- Suitable for products with universal clamp 1

Colours	Art.No.	EAN Code
	795+1505+000	4009729019788
	795+1502+000	4009729019771

2
Years
Guarantee





office organisation – mounting options



NOVUS Metal screw-on plate



- Robust metal screw-on plate for mounting in the desktop
- Fixing section: 51 mm
- Comes with metal screw sleeve
- Suitable for products with universal clamp 1

Colours	Art.No.	EAN Code
	795+1605+002	4009729029985
	795+1602+002	4009729032411



NOVUS drilling screw fitting



- Drilling screw attachment for mounting on the table
- Drilling diameter: 14mm
- Suitable for products with universal clamp 1

Colours	Art.No.	EAN Code
	796+0345+000	4009729030394
	796+0342+000	4009729026441



NOVUS wall mount metall standard

- Wall bracket for attachment to the wall, depending on the wall texture
- Suitable for products with universal clamp 1 or 2



Colours	Art.No.	EAN Code
	796+0842+000	4009729045145
	796+0849+000	4009729044704





NOVUS plastic wall bracket



- Wall mount in plastic for attachment to the wall, depending on the wall texture
- Suitable for products with universal clamp 1

Colours	Art.No.	EAN Code
	795+2002+000	4009729019795
	795+2005+000	4009729019801



NOVUS height increase set

- Adapter for all office organisation products mounted with universal clamp 1
- Provides a greater distance between the work surface universal supporting arm or a light
- Height increase by 124 mm
- Suitable for products with universal clamp 1

Colours	Art.No.	EAN Code
	795+2125+000	4009729027158
	795+2122+000	4009729027141



NOVUS SlatWall adapter

- SlatWall adapter to mount various products on organisation rails
- Carrying capacity 8 Kg
- Suitable for products with universal clamp 1 or 2 and LiftTEC monitor arms

Colours	Art.No.	EAN Code
	796+0839+001	4009729052549



office organisation – mounting options



NOVUS TSS column adapter

- Adapter for attaching various products to the TSS-column
- Suitable for products with universal clamp 1 or 2 and LiftTEC monitor arms

Colours	Art.No.	EAN Code
	796+0829+000	4009729043851

2
Years
Guarantee



Mounting options

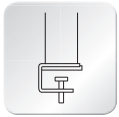

System clamp

Desktop mount with system clamp to mount the product without the need to drill holes in the desktop.



Ceiling mount

Ceiling mount lets you attach the product to the ceiling.



Attenzia clamp

Desktop mount for Attenzia lights to mount the product without the need to drill holes in the desktop.



Ceiling/floor mount

Ceiling/floor mount lets you mount a column between ceiling and floor.



Drilling screw fitting

Drilling screw fitting to mount the product by drilling a hole in the desktop.



Wall mount

Wall mount lets you attach the product to the wall.



Cable port mount

Cable port mount ensures secure attachment on existing cable ports.



Floor stand

Sturdy stand for positioning on the floor.



Pin adapter

Desktop mounting with pin adapter (16 mm in diameter) is used in various desk adapters by the office furniture industry.

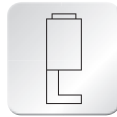

Universal clamp

Desktop mount with universal clamp 1 for desktops in a thickness of 18-74 mm.



System rail mount

System rail mount for use in various system rails from the office furniture industry.



Luma clamp

Desktop mount with luma clamp to mount the product without the need to drill holes in the desktop.



Desk stand

Elegant stand for positioning on the desk.



Combinability

All items with universal clamp 1 can be fitted to the product.



Organisation wall mount

Organisation wall mount to attach the products to an organisational wall by using slot nuts.

Technical specifications



Standard monitor mount

The standard mount to use with any monitor compatible with 75 x 75 mm or 100 x 100 mm attachment standard.



Column length

The value indicates the height of the column above the desk in mm.

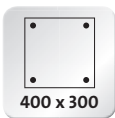

Monitor mount

This mount is to attach monitors compatible with the attachment standard given in mm. (The maximum possible standard is indicated.)



Height above desk

The value indicates the minimum and maximum distance between the product and desk surface.



Monitor weight

This value indicates the maximum load-bearing capacity of the supporting element or the maximum weight of a monitor in kg.

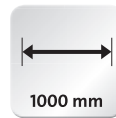

Width

The value indicates the width of the product in mm.



Carrying capacity

The weight shows the maximum weight in kg that the product is allowed to carry.



Range

The value indicates the product's range in mm.



Dimensions of support platform

The value indicates the size of the platform in mm.



Swivelling range

The value indicates the product's possible swivelling range in °.



Adjustability

The patented spring balancing mechanism gives the product very easy, infinitely variable adjustment.

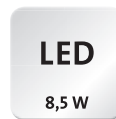

Power consumption

The value indicates the lamp used and its wattage.



Adjustability

The product can be engaged in 3 fixed positions.

Architecture

emcobad
emcobau
emcoklima

Worklife

novus**office**
novus**fastening**
dahle**office**

Mobility

emcoe-**scooter**



novus**office**



office products
More space system
logo mats

novus**fastening**

tackers
rivetry tools

dahle**office**



cutting machines
cutting instruments
document shredders
presentation systems
office machines
air purifiers

Novus & Dahle:

quality, function & design

competences under one roof.

Since seven decades the emco Group stands for premium quality, „German Engineering“ and product innovation. Today the emco Group combines four strong brands under one roof: emco, Novus, Dahle, and emco e-scooter with an international sales network throughtout the world.

Novus and Dahle, the experts for office products. The wide product range offers a great variety of tackers and rivetieng tools for home, hobby and professional use.



Novus office products



Novus logo mats



Novus fastening



Dahle cutting



Dahle document shredders



Dahle presentation systems





The intelligent use of space.



855-2593 EN 01/17
Technical data and design approximate and subject to change.

Novus Dahle GmbH & Co. KG
Novus more space system
Breslauer Straße 34 - 38
GER - 49808 Lingen (Ems)
Phone +49 (0) 591 9140-0
Fax +49 (0) 591 9140-841
info@novus-dahle.com

 **www.novus.de**
new england lab
laboratory furniture systems

888.635.2080 | newenglandlab.com

A company of the 